

# TOSHIBA

## Industrial Inverter (For 3-phase induction motors)

---

### Instruction Manual

---

# TOSVERT™ VF-nC3

< Simplified manual >

1-phase 120V class	0.1 to 0.75kW
1-phase 240V class	0.1 to 2.2kW
3-phase 240V class	0.1 to 4kW

#### NOTICE

1. Make sure that this instruction manual is delivered to the end user of the inverter unit.
2. Read this manual before installing or operating the inverter unit, and store it in a safe place for reference.



E6581597①

Safety precautions	<i>I</i>
Introduction	<i>II</i>
Contents	
Read first	<i>1</i>
Connection	<i>2</i>
Operations	<i>3</i>
Setting parameters	<i>4</i>
Main parameters	<i>5</i>
Other parameters	<i>6</i>
Operation with external signal	<i>7</i>
Monitoring the operation status	<i>8</i>
Measures to satisfy the standards	<i>9</i>
Peripheral devices	<i>10</i>
Table of parameters and data	<i>11</i>
Specifications	<i>12</i>
Before making a service call	<i>13</i>
Inspection and maintenance	<i>14</i>
Warranty	<i>15</i>
Disposal of the inverter	<i>16</i>

# I. Safety precautions

The items described in these instructions and on the inverter itself are very important so that you can use the inverter safely, prevent injury to yourself and other people around you as well as to prevent damage to property in the area. Thoroughly familiarize yourself with the symbols and indications shown below and then continue to read the manual. Make sure that you observe all warnings given.



## Explanation of markings

Marking	Meaning of marking
 <b>Warning</b>	Indicates that errors in operation may lead to death or serious injury.
 <b>Caution</b>	Indicates that errors in operation may lead to injury (*1) to people or that these errors may cause damage to physical property. (*2)

(\*1) Such things as injury, burns or shock that will not require hospitalization or long periods of outpatient treatment.

(\*2) Physical property damage refers to wide-ranging damage to assets and materials.

## Meanings of symbols

Marking	Meaning of marking
	Indicates prohibition (Don't do it). What is prohibited will be described in or near the symbol in either text or picture form.
	Indicates an instruction that must be followed. Detailed instructions are described in illustrations and text in or near the symbol.
	-Indicates warning. What is warned will be described in or near the symbol in either text or picture form. -Indicates caution. What the caution should be applied to will be described in or near the symbol in either text or picture form.

## ■ Limits in purpose

This inverter is used for controlling speeds of three-phase induction motors in general industrial use.







Single-phase power input is output by the inverter as 3-phase output and cannot drive a single-phase motor.





### Safety precautions



- ▼ The inverter cannot be used in any device that would present danger to the human body or from which malfunction or error in operation would present a direct threat to human life (nuclear power control device, aviation and space flight control device, traffic device, life support or operation system, safety device, etc.). If the inverter is to be used for any special purpose, first get in touch with the supplier.
- ▼ This product was manufactured under the strictest quality controls but if it is to be used in critical equipment, for example, equipment in which errors in malfunctioning signal output system would cause a major accident, safety devices must be installed on the equipment.
- ▼ Do not use the inverter for loads other than those of properly applied three-phase induction motors in general industrial use. (Use in other than properly applied three-phase induction motors may cause an accident.)



## ■ General Operation

 <b>Warning</b>		Reference section
 Disassembly prohibited	<ul style="list-style-type: none"> <li>Never disassemble, modify or repair. This can result in electric shock, fire and injury. For repairs, call your sales distributor.</li> </ul>	2.
 Prohibited	<ul style="list-style-type: none"> <li>Do not open the terminal block cover while the inverter is on. The unit contains many high voltage parts and contact with them will result in electric shock.</li> <li>Do not stick your fingers into openings such as cable wiring holes and cooling fan covers. This can result in electric shock or other injury.</li> <li>Do not place or insert any kind of object into the inverter (electrical wire cuttings, rods, wires etc.). This can result in electric shock or fire.</li> <li>Do not allow water or any other fluid to come in contact with the inverter. This can result in electric shock or fire.</li> </ul>	2.1 2. 2. 2.
 Mandatory action	<ul style="list-style-type: none"> <li>After replacing the terminal block cover, turn the input power on. Turning on the input power without replacing the terminal block cover may lead to electric shock.</li> <li>If the inverter begins to emit smoke or an unusual odor, or unusual sounds, immediately turn power off. If the equipment is continued in operation in such a state, the result may be fire. Call your local sales agency for repairs.</li> <li>Always turn power off if the inverter is not used for long periods of time since there is a possibility of malfunction caused by leaks, dust and other material. If power is left on with the inverter in that state, it may result in fire.</li> </ul>	2.1 3. 3.
 <b>Caution</b>		Reference section
 Contact prohibited	<ul style="list-style-type: none"> <li>Do not touch heat radiating fins or discharge resistors. These devices are hot, and you'll get burned if you touch them.</li> </ul>	3.
 Mandatory action	<ul style="list-style-type: none"> <li>Use an inverter that conforms to the specifications of power supply and three-phase induction motor being used. If the inverter being used does not conform to those specifications, not only will the three-phase induction motor not rotate correctly, it may also cause serious accidents through overheating and fire.</li> </ul>	1.1



■ Transportation & installation





 <b>Warning</b>		Reference section
 Prohibited	<ul style="list-style-type: none"> <li>Do not install or operate the inverter if it is damaged or any component is missing. This can result in electric shock or fire. Please consult your local sales agency for repairs. Call your local sales agency for repairs.</li> </ul>	1.4.4
	<ul style="list-style-type: none"> <li>Do not place any inflammable objects nearby. If a flame is emitted due to malfunction, it may result in a fire.</li> </ul>	1.4.4
	<ul style="list-style-type: none"> <li>Do not install in any location where the inverter could come into contact with water or other fluids. This can result in electric shock or fire.</li> </ul>	1.4.4



 <b>Warning</b>		Reference section
 Mandatory action	<ul style="list-style-type: none"> <li>Must be used in the environmental conditions prescribed in the instruction manual. Use under any other conditions may result in malfunction.</li> </ul>	1.4.4
	<ul style="list-style-type: none"> <li>Mount the inverter on a metal plate. The rear panel gets very hot. Do not install in an inflammable object, this can result in fire.</li> </ul>	1.4.4
	<ul style="list-style-type: none"> <li>Do not use the inverter without the terminal block cover. This can result in electric shock. Failure to do so can lead to risk of electric shock and can result in death or serious injury.</li> </ul>	1.4.4
	<ul style="list-style-type: none"> <li>An emergency stop device must be installed that fits with system specifications (e.g. shut off input power then engage mechanical brake). Operation cannot be stopped immediately by the inverter alone, thus risking an accident or injury.</li> </ul>	1.4.4
	<ul style="list-style-type: none"> <li>All options used must be those specified by Toshiba. The use of any other option may result in an accident.</li> </ul>	1.4.4
<ul style="list-style-type: none"> <li>When using switchgear for the inverter, it must be installed in a cabinet. Failure to do so can lead to risk of electric shock and can result in death or serious injury.</li> </ul>	10	



 <b>Caution</b>		Reference section
 Prohibited	<ul style="list-style-type: none"> <li>When transporting or carrying, do not hold by the front panel covers. The covers may come off and the unit will drop out resulting in injury.</li> </ul>	2.
	<ul style="list-style-type: none"> <li>Do not install in any area where the unit would be subject to large amounts of vibration. That could result in the unit falling, resulting in injury.</li> </ul>	1.4.4
 Mandatory action	<ul style="list-style-type: none"> <li>When removing and installing the terminal cover with a screwdriver, be sure not to scratch your hand as this results in injury.</li> </ul>	1.3.2
	<ul style="list-style-type: none"> <li>Pressing too hard on the screwdriver may scratch the inverter.</li> </ul>	1.3.2
	<ul style="list-style-type: none"> <li>Always cut the power supply when removing the wiring cover.</li> </ul>	1.3.2
	<ul style="list-style-type: none"> <li>After wiring is complete, be sure to replace the terminal cover.</li> </ul>	1.4.4
<ul style="list-style-type: none"> <li>The main unit must be installed on a base that can bear the unit's weight. If the unit is installed on a base that cannot withstand that weight, the unit may fall resulting in injury.</li> </ul>	1.4.4	
<ul style="list-style-type: none"> <li>If braking is necessary (to hold motor shaft), install a mechanical brake. The brake on the inverter will not function as a mechanical hold, and if used for that purpose, injury may result.</li> </ul>	1.4.4	

## ■ Wiring



 <b>Warning</b>		Reference section
 Prohibited	<ul style="list-style-type: none"> <li>Do not connect input power to the output (motor side) terminals (U/T1,V/T2,W/T3). That will destroy the inverter and may result in fire.</li> </ul>	2.2
	<ul style="list-style-type: none"> <li>Do not connect resistors to the DC terminals (across PA+ - PC/- or PO-PC/-). That may cause a fire.</li> </ul>	2.2
	<ul style="list-style-type: none"> <li>Within 15 minutes after turning off input power, do not touch wires of devices (MCCB) connected to the input side of the inverter. That could result in electric shock.</li> </ul>	2.2
	<ul style="list-style-type: none"> <li>When supplying power from a wall socket, do not exceed the rated capacity of the socket. Otherwise, this may generate excessive heat which can start a fire.</li> </ul>	10.



 <b>Warning</b>		Reference section
 Mandatory action	<ul style="list-style-type: none"> <li>Electrical installation work must be done by a qualified expert. Connection of input power by someone who does not have that expert knowledge may result in fire or electric shock.</li> </ul>	2.1
	<ul style="list-style-type: none"> <li>Connect output terminals (motor side) correctly. If phase sequence is incorrect, motor will operate in reverse and that may result in injury.</li> </ul>	2.1
	<ul style="list-style-type: none"> <li>Wiring must be done after installation. If wiring is done prior to installation that may result in injury or electric shock</li> </ul>	2.1
	<ul style="list-style-type: none"> <li>The following steps must be performed before wiring.               <ol style="list-style-type: none"> <li>Turn off all input power.</li> <li>Wait at least 15 minutes and check to make sure that the charge lamp is no longer lit.</li> <li>Use a tester that can measure DC voltage (400VDC or more), and check to make sure that the voltage to the DC main circuits (across PA+ - PC/-) is 45V or less. If these steps are not properly performed, the wiring will cause electric shock.</li> </ol> </li> </ul>	2.1
 Be Grounded	<ul style="list-style-type: none"> <li>Tighten the screws on the terminal board to specified torque. If the screws are not tightened to the specified torque, it may lead to fire.</li> </ul>	2.1
	<ul style="list-style-type: none"> <li>Check to make sure that the input power voltage is +10%, -15% of the rated power voltage written on the rating label (<math>\pm 10\%</math> when the load is 100% in continuous operation). If the input power voltage is not +10%, -15% of the rated power voltage (<math>\pm 10\%</math> when the load is 100% in continuous operation) this may result in fire.</li> </ul>	1.4.4
 Be Grounded	<ul style="list-style-type: none"> <li>Set a parameter <math>F</math> <math>\rightarrow</math> <math>\rightarrow</math> when VIA or VIB terminals are used as logic input terminal. If it is not set, it could result in malfunction.</li> </ul>	2.2
	<ul style="list-style-type: none"> <li>Ground must be connected securely. If the ground is not securely connected, it could lead to electric shock or fire when a malfunction or current leak occurs.</li> </ul>	2.1 2.2 10.



 <b>Caution</b>		Reference section
 Prohibited	<ul style="list-style-type: none"> <li>Do not attach equipment (such as noise filters or surge absorbers) that have built-in capacitors to the output (motor side) terminals. That could result in a fire.</li> </ul>	2.1

 <b>Warning</b>		Reference section
 Mandatory action	<ul style="list-style-type: none"> <li>Configuring settings on the setup menu incorrectly may break the inverter or lead to malfunction.</li> </ul>	3.1



## ■ Operations

 <b>Warning</b>		Reference section
 Prohibited	<ul style="list-style-type: none"> <li>Never touch the internal terminals in the upper right while the front cover is open. There is a risk of shock because it carries a high voltage.</li> </ul>	1.3.1



 <b>Warning</b>		Reference section
 Prohibited	<ul style="list-style-type: none"> <li>Do not touch inverter terminals when electrical power is going to the inverter even if the motor is stopped. Touching the inverter terminals while power is connected to it may result in electric shock.</li> <li>Do not touch switches when the hands are wet and do not try to clean the inverter with a damp cloth. Such practices may result in electric shock.</li> <li>Do not go near the motor in alarm-stop status when the retry function is selected. The motor may suddenly restart and that could result in injury. Take measures for safety, e.g. attaching a cover to the motor, against accidents when the motor unexpectedly restarts.</li> </ul>	3. 3. 3.
 Mandatory action	<ul style="list-style-type: none"> <li>After replacing the terminal block cover, turn the input power on. When installed inside a cabinet and using with the front cover removed, always close the cabinet doors first and then turn power on. Turning on the power with the terminal block cover or cabinet doors open may result in electric shock.</li> <li>Make sure that operation signals are off before resetting the inverter after malfunction. If the inverter is reset before turning off the operating signal, the motor may restart suddenly causing injury.</li> </ul>	3. 3.

 <b>Caution</b>		Reference section
 Prohibited	<ul style="list-style-type: none"> <li>Observe all permissible operating ranges of motors and mechanical equipment. (Refer to the motor's instruction manual.) Not observing these ranges may result in injury.</li> <li>Do not set the stall prevention level (<math>F_{\text{SD}}^{\text{st}}</math>) extremely low. If the stall prevention level parameter (<math>F_{\text{SD}}^{\text{st}}</math>) is set at or below the no-load current of the motor, the stall preventive function will be always active and increase the frequency when it judges that regenerative braking is taking place. Do not set the stall prevention level parameter (<math>F_{\text{SD}}^{\text{st}}</math>) below 30% under normal use.</li> </ul>	3. 6.16.2
 Mandatory action	<ul style="list-style-type: none"> <li>Use an inverter that conforms to the specifications of power supply and three-phase induction motor being operated. If the inverter being used does not conform to those specifications, not only will the three-phase induction motor not rotate correctly, but it may cause serious accidents through overheating and fire.</li> <li>Current may leak through the inverter's input/output wires because of insufficient electrostatic capacity on the motor with bad effects on peripheral equipment. The leakage current's value is affected by the carrier frequency and the length of the input/output wires. Test and adopt the remedies of section 1.4.3 against leak current.</li> </ul>	1.4.1 1.4.3



## ■ When operation by using remote keypad is selected

 Warning		Reference section
 Mandatory action	<ul style="list-style-type: none"> <li>Set the parameter Communication time-out time (<i>F B 0 3</i>) and Communication time-out action (<i>F B 0 4</i>). If these are not properly set, the inverter can not be stopped immediately in breaking communication and this could result in injury and accidents.</li> <li>An emergency stop device and the interlock that fit with system specifications must be installed. If these are not properly installed, the inverter can not be stopped immediately and this could result in injury and accidents.</li> </ul>	E6581595, 6.19



## ■ When sequence for restart after a momentary failure is selected (inverter)

 Caution		Reference section
 Mandatory action	<ul style="list-style-type: none"> <li>Stand clear of motors and mechanical equipment. If the motor stops due to a momentary power failure, the equipment will start suddenly after power recovers. This could result in unexpected injury.</li> <li>Attach caution label about sudden restart after a momentary power failure on inverters, motors and equipment for prevention of accidents in advance.</li> </ul>	E6581595, 6.12.1 E6581595, 6.12.1



## ■ When retry function is selected (inverter)

 Caution		Reference section
 Mandatory action	<ul style="list-style-type: none"> <li>Stand clear of motors and equipment. If the motor and equipment stop when the alarm is given, selection of the retry function will restart them suddenly after the specified time has elapsed. This could result in unexpected injury.</li> <li>Attach caution label about sudden restart in retry function on inverters, motors and equipment for prevention of accidents in advance.</li> </ul>	E6581595, 6.12.3 E6581595, 6.12.3

## ■ Maintenance and inspection

 Warning		Reference section
 Prohibited	<ul style="list-style-type: none"> <li>Do not replace parts. This could be a cause of electric shock, fire and bodily injury. To replace parts, call the local sales agency.</li> </ul>	14.2
 Mandatory action	<ul style="list-style-type: none"> <li>The equipment must be inspected every day. If the equipment is not inspected and maintained, errors and malfunctions may not be discovered and that could result in accidents.</li> <li>Before inspection, perform the following steps.               <ol style="list-style-type: none"> <li>Turn off all input power to the inverter.</li> <li>Wait at least 15 minutes and check to make sure that the charge lamp is no longer lit.</li> <li>Use a tester that can measure DC voltages (400VDC or more), and check to make sure that the voltage to the DC main circuits (across PA/+ - PC/-) is 45V or less.</li> </ol>               If inspection is performed without performing these steps first, it could lead to electric shock.             </li> </ul>	14. 14. 14.2

■ Disposal

 <b>Caution</b>		Reference section
 Mandatory action	<ul style="list-style-type: none"> <li>If you dispose of the inverter, have it done by a specialist in industry waste disposal(*). If you dispose of the inverter in an inappropriate way, this can result in explosion of capacitor or produce noxious gases, resulting in injury.</li> <li>(* ) Persons who specialize in the processing of waste and known as "industrial waste product collectors and transporters" or "industrial waste disposal persons." If the collection, transport and disposal of industrial waste is done by someone who is not licensed for that job, it is a punishable violation of the law. (Laws in regard to cleaning and processing of waste materials)</li> </ul>	16.

■ Attach caution labels

Shown here are examples of warning labels to prevent, in advance, accidents in relation to inverters, motors and other equipment.

Be sure to affix the caution label where it is easily visible when selecting the auto-restart function (6.12.1) or the retry function (6.12.3).

If the inverter has been programmed for restart sequence of momentary power failure, place warning labels in a place where they can be easily seen and read.  
(Example of caution label)

	<b>Caution (Functions programmed for restart)</b>
Do not go near motors and equipment. Motors and equipment that have stopped temporarily after momentary power failure will restart suddenly after recovery.	

If the retry function has been selected, place warning labels in a location where they can be easily seen and read.  
(Example of caution label)

	<b>Caution (Functions programmed for retry)</b>
Do not go near motors and equipment. Motors and equipment that have stopped temporarily after an alarm will restart suddenly after the specified time has elapsed.	



## II. Introduction

---

---

Thank you for your purchase of the Toshiba "TOSVERT VF-nC3" industrial inverter.

This instruction manual is for the Ver. 106 or later CPU of the inverter.  
Please be informed that CPU version will be frequently upgraded.

## — Contents —

I	Safety precautions .....	1
II	Introduction .....	8
1.	Read first .....	A-1
1.1	Check product purchase .....	A-1
1.2	Contents of the product .....	A-2
1.3	Names and functions .....	A-3
1.4	Notes on the application .....	A-12
2.	Connection .....	B-1
2.1	Cautions on wiring .....	B-1
2.2	Standard connections .....	B-3
2.3	Description of terminals .....	B-6
3.	Operations .....	C-1
3.1	How to Set the Setup Menu .....	C-2
3.2	Simplified Operation of the VF-nC3 .....	C-4
3.3	How to operate the VF-nC3 .....	C-9
3.4	Meter setting and adjustment .....	C-13
3.5	Setting the electronic thermal .....	C-16
3.6	Preset-speed operation (speeds in 15 steps) .....	C-21
4.	Setting parameters .....	D-1
4.1	Setting and Display Modes .....	D-1
4.2	How to set parameters .....	D-3
4.3	Functions useful in searching for a parameter or changing a parameter setting .....	D-7
4.4	Checking the region settings selection .....	D-12
4.5	EASY key function .....	D-13
5.	Main parameters .....	E-1
6.	Other parameters .....	F-1
7.	Operations with external signal .....	G-1
8.	Monitoring the operation status .....	H-1
8.1	Flow of status monitor mode .....	H-1
8.2	Status monitor mode .....	H-2
8.3	Display of trip information .....	H-6

9. Measures to satisfy the standards.....	I-1
9.1 How to cope with the CE directive.....	I-1
9.2 Compliance with UL Standard and CSA Standard.....	I-5
10. Peripheral devices.....	J-1
10.1 Selection of wiring materials and devices.....	J-1
10.2 Installation of a magnetic contactor.....	J-3
10.3 Installation of an overload relay.....	J-4
10.4 Optional external devices.....	J-5
11. Table of parameters and data.....	K-1
11.1 User parameters.....	K-1
11.2 Basic parameters.....	K-1
11.3 Extended parameters.....	K-4
11.4 Default settings by inverter rating.....	K-15
11.5 Default settings by setup menu.....	K-15
11.6 Input Terminal Function.....	K-16
11.7 Output Terminal Function.....	K-19
12. Specifications.....	L-1
12.1 Models and their standard specifications.....	L-1
12.2 Outside dimensions and mass.....	L-4
13. Before making a service call - Trip information and remedies.....	M-1
13.1 Trip causes/warnings and remedies.....	M-1
13.2 Restoring the inverter from a trip.....	M-6
13.3 If the motor does not run while no trip message is displayed.....	M-7
13.4 How to determine the causes of other problems.....	M-8
14. Inspection and maintenance.....	N-1
14.1 Regular inspection.....	N-1
14.2 Periodical inspection.....	N-2
14.3 Making a call for servicing.....	N-4
14.4 Keeping the inverter in storage.....	N-4
15. Warranty.....	O-1
16. Disposal of the inverter.....	P-1

# 1. Read first

## 1.1 Check product purchase

Before using the product you have purchased, check to make sure that it is exactly what you ordered.

<b>⚠ Caution</b>	
<b>!</b> Mandatory action	Use an inverter that conforms to the specifications of power supply and three-phase induction motor being used. If the inverter being used does not conform to those specifications, not only will the three-phase induction motor not rotate correctly, it may also cause serious accidents through overheating and fire.

1

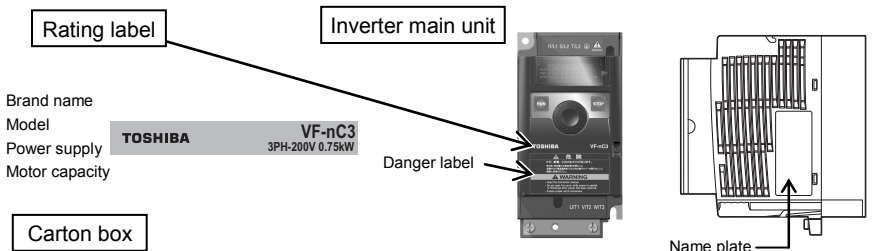

Brand name  
Model  
Power supply  
Motor capacity

**TOSHIBA**      **VF-nC3**  
**3PH-200V 0.75kW**

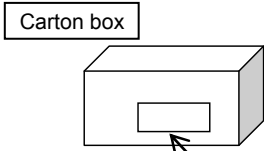

**⚠ 警告**

⚠ **DANGER**

Risk of injury, electric shock or fire.  
Do not touch the inverter housing.  
Do not open the cover while power is applied.  
If the cover is opened, the power must be removed.  
Ensure proper earth connection.

**⚠ 警告**

⚠ **DANGER**

Risk of injury, electric shock or fire.  
Do not touch the inverter housing.  
Do not open the cover while power is applied.  
If the cover is opened, the power must be removed.  
Ensure proper earth connection.

Setup sheet

U	V	W	R	S	T	P	N	G
Phase	Phase	Phase	Phase	Phase	Phase	Phase	Phase	Phase
200V	200V	200V	200V	200V	200V	200V	200V	200V
0.75kW	0.75kW	0.75kW	0.75kW	0.75kW	0.75kW	0.75kW	0.75kW	0.75kW

**TOSHIBA**  
TRANSISTOR INVERTER  
**VFNC3S-2022PL**

2.2kW-4.1kVA-3HP (11)

INPUT	OUTPUT
110V 1PH 200/240	3PH 200/240
50/60	0.14/0.9
1/2	21.9/18.4
S.C.H. 100VA FUSE CCUJ 30Amax	

Serial No. 1328 02021208 0001  
Made in -----

Motor Overload Protection Class 10

CSA-BM USABME-417.5

**SP** 231252

**UL** LISTED 170M IND. CONT.EQ. E294788

**CE**

TOSHIBA INDUSTRIAL PRODUCTS SALES CO. TSIJ

**Instruction manual**

E6581597

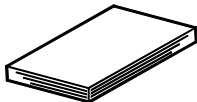

**CD-ROM**

Contains the instruction manual in digital form



**Danger label kit**

Danger labels for sticking in 6 languages

<p><b>⚠ DANGER</b>  <b>Risk of injury, electric shock or fire.</b>                  • Read the instruction manual.                  • Do not open the cover while power is applied or for 15 minutes after power has been removed.                  • Ensure proper earth connection.</p>	<p><b>⚠ ADVERTENCIA</b>                  Riesgo de lesiones, descarga eléctrica o fuego.                  • Lea el manual de instrucciones.                  • Advertencia: no abra el gabinete.                  • Advertencia: espere 15 minutos.                  • Asegure una conexión correcta a tierra.</p>
<p><b>⚠ WARNING</b>                  Gefahr von Verletzungen, elektrischem Schlag oder Brand.                  • Lesen Sie die Bedienungsanleitung.                  • Warnhinweis: Schließen Sie nicht auf.                  • Warnhinweis: Warten Sie 15 Minuten.                  • Sorgen Sie für eine korrekte Erdverdrahtung.</p>	<p><b>⚠ 警告</b>                  危険な作業、感電、発火の恐れがあります。                  • 取扱説明書をお読みください。                  • 警告：カバーを開かないでください。                  • 警告：15分間お待ちください。                  • 接地接続を適切に行ってください。</p>
<p><b>⚠ DANGER</b>                  Risk of injury, electric shock or fire.                  • Read the instruction manual. • Ensure proper earth connection.                  • Do not open the cover while power is applied or for 15 minutes after power has been removed.</p>	<p><b>⚠ DANGER</b>                  Risk of injury, electric shock or fire.                  • Read the instruction manual. • Ensure proper earth connection.                  • Do not open the cover while power is applied or for 15 minutes after power has been removed.</p>
<p><b>⚠ AVVERTENZA</b>                  Rischio di lesioni, scossa elettrica o incendio.                  • Leggere attentamente il manuale di istruzioni.                  • Avvertenza: non aprire il coperchio.                  • Avvertenza: attendere 15 minuti.                  • Assicurare un'adeguata messa a terra.</p>	<p><b>⚠ AVERTISSEMENT</b>                  Risque de blessures, choc électrique ou incendie.                  • Lire attentivement le mode d'emploi.                  • Attention: ne pas ouvrir le couvercle.                  • Attention: attendre 15 minutes avant de réinitialiser.                  • Assurer un raccordement approprié à la terre.</p>
<p><b>⚠ DANGER</b>                  Risk of injury, electric shock or fire.                  • Read the instruction manual. • Ensure proper earth connection.                  • Do not open the cover while power is applied or for 15 minutes after power has been removed.</p>	<p><b>⚠ DANGER</b>                  Risk of injury, electric shock or fire.                  • Read the instruction manual. • Ensure proper earth connection.                  • Do not open the cover while power is applied or for 15 minutes after power has been removed.</p>

## 1.2 Contents of the product

Explanation of the name plate label.

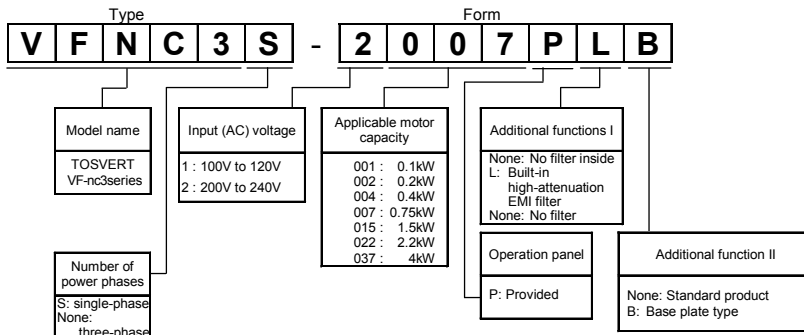

Note 1) Always shut power off first then check the ratings label of inverter held in a cabinet.

Note 2) ID label is stuck for special specification product.

## 1.3 Names and functions

### 1.3.1 Outside view

With cover closed

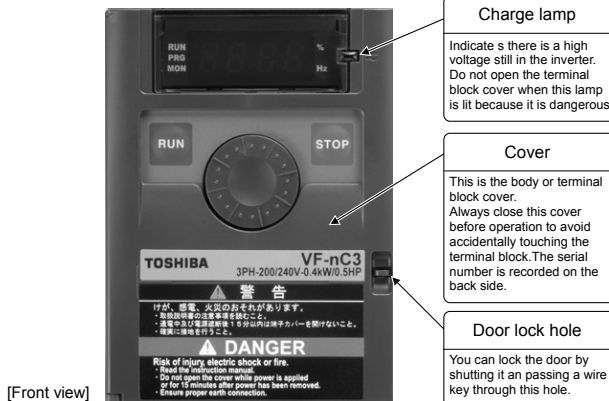

Hole for control wire

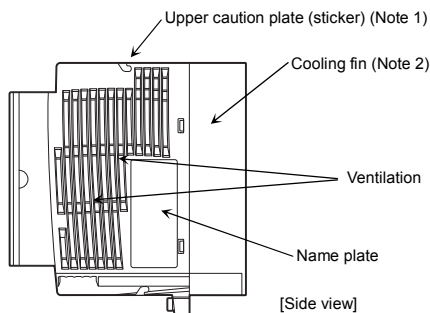
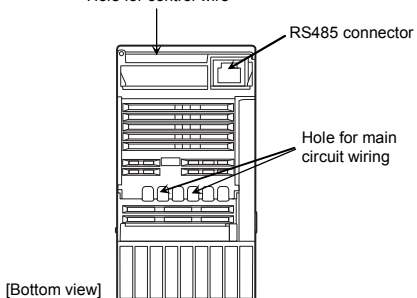

Note 1) Remove the seal as shown on the next page when installing the inverter side by side with other inverters where the ambient temperature will rise above 40°C.

Note 2) Some models are wrapped in plastic.

Example of the label

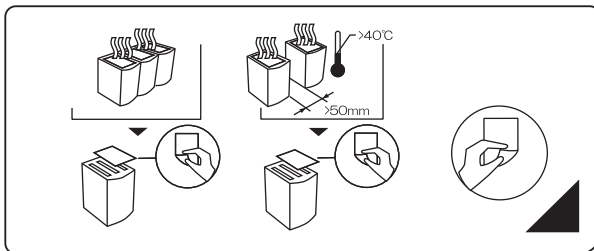

[Opening the cover]

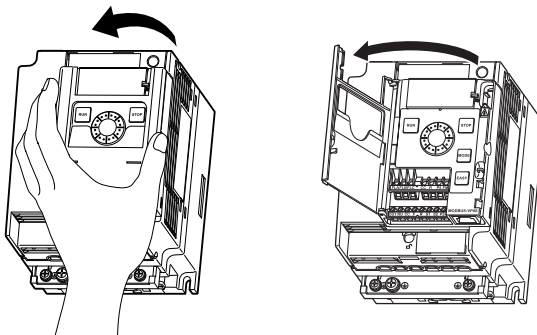

★About the monitor display

The LED on the operation panel uses the following symbols to indicate parameters and operations.

LED display (numbers)

0	1	2	3	4	5	6	7	8	9	-
0̄	1̄	2̄	3̄	4̄	5̄	6̄	7̄	8̄	9̄	-

LED display (letters)

Aa	Bb	C	c	Dd	Ee	Ff	Gg	H	h	I	i	Jj	Kk	Ll
Ā	b̄	C̄	c̄	D̄	Ē	F̄	Ḡ	H̄	h̄	Ī	ī	J̄	K̄	L̄
Mm	Nn	O	o	Pp	Qq	Rr	Ss	Tt	Uu	Vv	Ww	Xx	Yy	Zz
M̄	n̄	Ō	ō	P̄	q̄	r̄	S̄	t̄	Ū	v̄	W̄	X̄	Ȳ	Z̄

<b>Warning</b>	
 Prohibited	<ul style="list-style-type: none"> <li>Never touch the internal terminals in the upper right while the front cover is open. There is a risk of shock because it carries a high voltage.</li> </ul>

[With cover open]

1

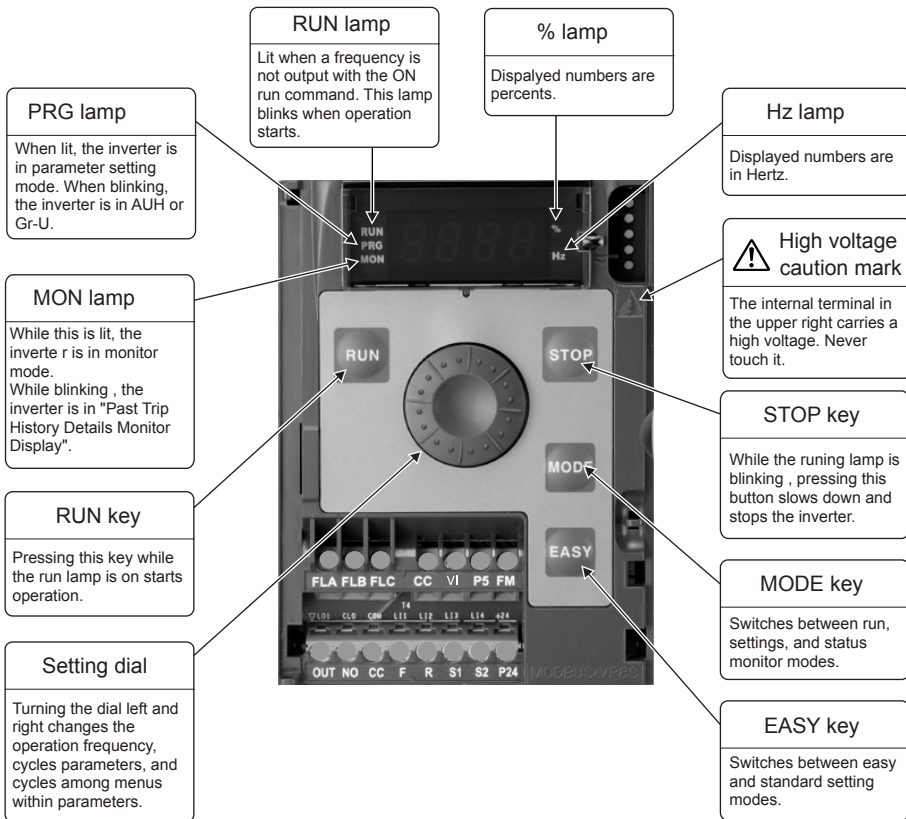



## 1.3.2 Opening the terminal cover

### Caution



Mandatory  
action

- When removing and installing the terminal cover with a screwdriver, be sure not to scratch your hand as this results in injury.
- Pressing too hard on the screwdriver may scratch the inverter.
- Always cut the power supply when removing the wiring cover.
- After wiring is complete, be sure to replace the terminal cover.

Use the following procedure to remove both the upper and lower terminal block covers.

(1) Removing the lower (output and dc terminals) terminal block cover

1)

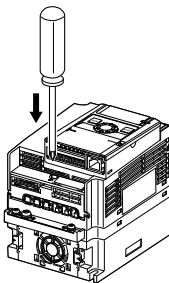

Insert a screwdriver or other thin object into the hole indicated with the ◁ mark.

2)

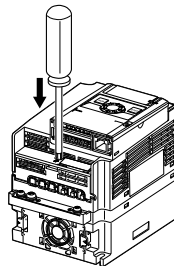

Press in on the screwdriver.

3)

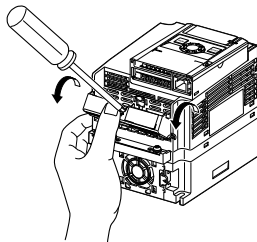

While pressing on the screwdriver, rotate the terminal cover downward to remove it.

4)

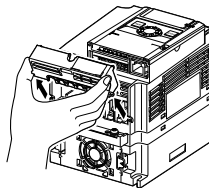

Pull the terminal cover up at an angle.

(2) Removing the upper terminal (input terminal) block cover

1)

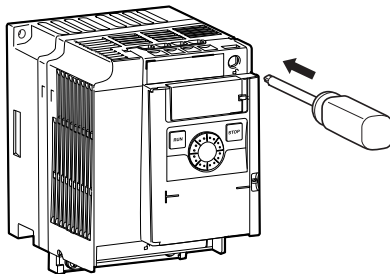

Insert a screwdriver or other thin object into the hole indicated with the □ mark.

2)

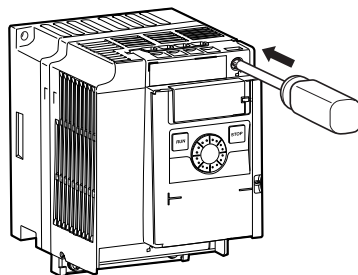

Press in on the screwdriver.

3)

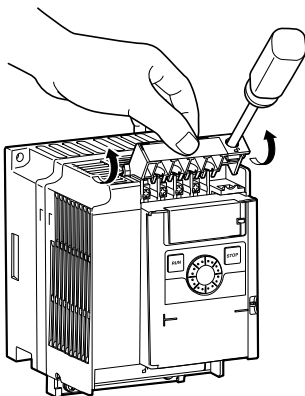

While pressing on the screwdriver, rotate the terminal cover upward to remove it.

4)

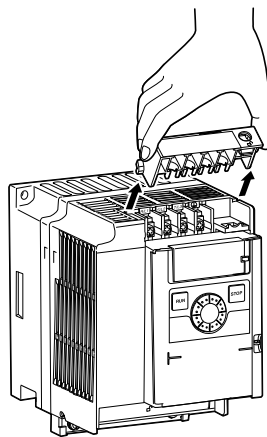

Pull the terminal cover up at an angle.

★ After wiring is complete, be sure to restore the terminal cover to its original position.

1

## 1.3.3 Power circuit and control circuit terminal boards

In case of the lug connector, cover the lug connector with insulated tube, or use the insulated lug connector.

Note 1: EMC plate is supplied as standard.

### 1) Power circuit terminal board

In case of the lug connector, cover the lug connector with insulated tube, or use the insulated lug connector.

Screw size	Tightening torque	
M3.5 screw	1.0Nm	8.9lb • in
M4 screw	1.4Nm	12.4lb • in
M5 screw	3.0Nm	26.6lb • in

Refer to section 2.3.1 for details about terminal functions.

VFNC3-2001 ~ 2007P

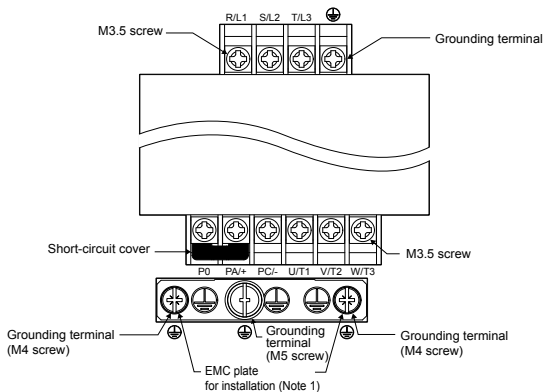

\* Bend the clips on the wiring port of the terminal cover to connect the PO, PA/+, and PC/- terminals.

VFNC3-2015 ~ 2037P

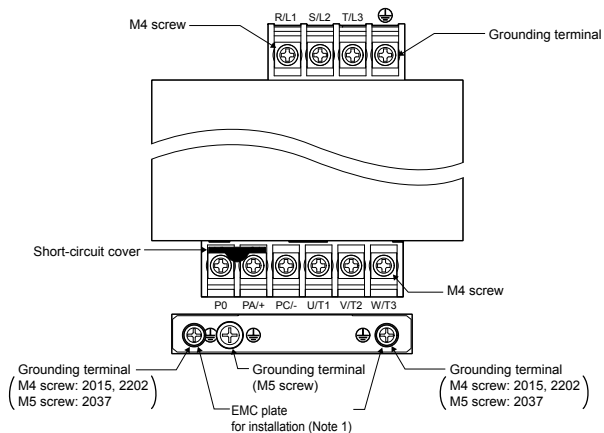

\* Bend the clips on the wiring port of the terminal cover to connect the PO, PA/+, and PC/- terminals.

VFNC3S-1001 ~ 1004P, 2001 ~ 2007PL

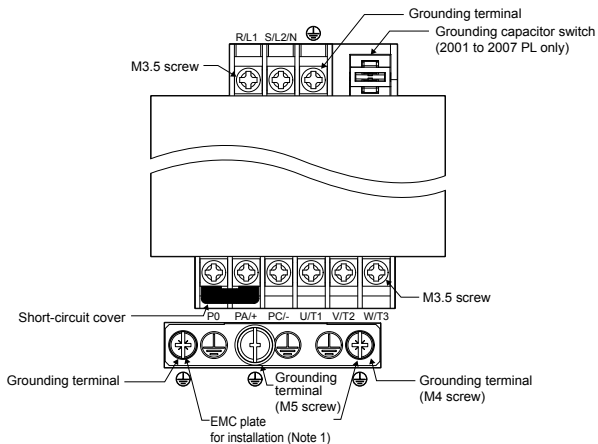

\* Bend the clips on the wiring port of the terminal cover to connect the PO, PA/+, and PC/- terminals.

VFNC3S-1007P, 2015PL, 2022PL

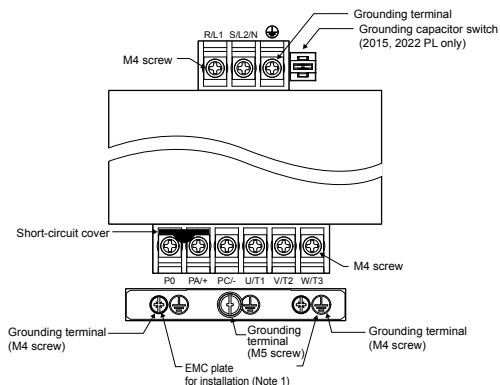

\* Bend the clips on the wiring port of the terminal cover to connect the PO, PA+, and PC/- terminals.

When using a crimping terminal, be sure to cover the fastener with an insulating tube or use an insulated crimping terminal.

Note 1) The EMC plate is optional.

## 2) Grounding capacitor switch

Single-phase 240 V models have a built-in high-attenuation noise filter and are grounded via a capacitor. A switch makes for easy switching to reduce leakage current from the inverter and the load on the capacitor. However, be careful, as reducing the load means non-conformity with the EMC standard on the inverter itself. Always do switching with the power off.

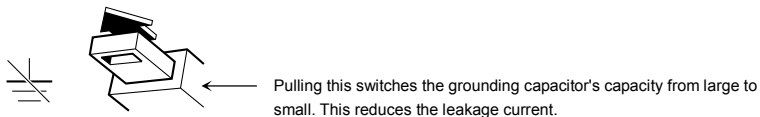
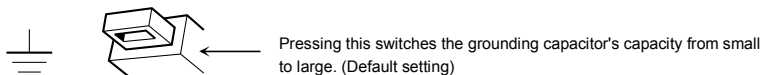

3) Control circuit terminal board

The control circuit terminal board is common to all equipment.

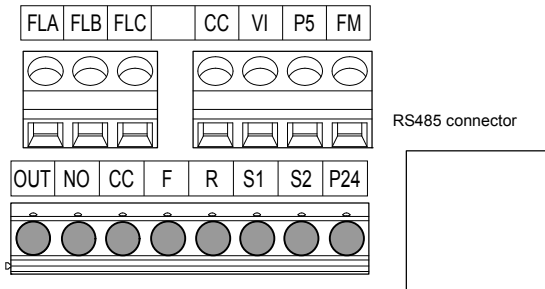

Screw size	Recommended tightening torque
M2.5 screw	0.5 N·m
	4.4 lb·in

Stripping length: 6 (mm)  
 Screwdriver: Small-sized flat-blade screwdriver  
 (Blade thickness: 0.5 mm, blade width: 3.5 mm)

Refer to section 2.3.2 for details about all terminal functions.

Wire size

Conductor	1 wire	2 wires of same size
Solid	0.3-1.5mm <sup>2</sup> (AWG 22-16)	0.3-0.75mm <sup>2</sup> (AWG 22-18)
Stranded		

Recommended ferrule

Using ferrule to be improved efficiency and reliability of wiring is recommended.

Wire size mm <sup>2</sup> (AWG)	Type	
	PHOENIX CONTACT	Dinkle International.,Ltd
0.34 (22)	AI 0.34-6TQ	DN00306
0.5 (20)	AI 0.5-6WH	DN00506
0.75 (18)	AI 0.75-6GY	DN00706
1 (18)	AI 1-6RD	DN01006
1.5 (16)	AI 1.5-8BK	DN01508
*2 2 X 0.5 (-)	AI TWIN2 X 0.5-8WH	DTE00508
*2 2 X 0.75 (-)	AI TWIN2 X 0.75-8GY	DTE00708



\*1: Crimping pliers CRIMPFOX ZA3 ( PHOENIX CONTACT )  
 CT1 ( Dinkle International.,Ltd )

\*2: These ferrules enable practical crimping of two wires in a ferrule.

## 1.4 Notes on the application

### 1.4.1 Motors

When the VF-nC3 and the motor are used in conjunction, pay attention to the following items.

 <b>Caution</b>	
 Mandatory action	Use an inverter that conforms to the specifications of power supply and three-phase induction motor being operated. If the inverter being used does not conform to those specifications, not only will the three-phase induction motor not rotate correctly, but it may cause serious accidents through overheating and fire.

#### Comparisons with commercial power operation

The VF-nC3 Inverter employs the sinusoidal PWM system. However, the output voltage and output current are not perfect sine waves, they have a distorted wave that is close to sinusoidal waveform. This is why compared to operation with a commercial power there will be a slight increase in motor temperature, noise and vibration.

#### Operation in the low-speed area

When running continuously at low speed in conjunction with a general purpose motor, there may be a decline in that motor's cooling effect. If this happens, operate with the output decreased from rated load. To carry out low-speed operation continuously at the rated torque, we recommend to use a inverter rated motor or a forced cooled motor designed for use with an inverter. When operating in conjunction with a inverter rated motor, you must change the inverter's motor overload protection level  $\overline{U}_L$  to VF motor use.

#### Adjusting the overload protection level

The VF-nC3 Inverter protects against overloads with its overload detection circuits (electronic thermal). The electronic thermal's reference current is set to the inverter's rated current, so it must be adjusted in line with the rated current of the motor being used in combination.

#### High speed operation at and above 60Hz

Operating at frequencies greater than 60Hz will increase noise and vibration. There is also a possibility this will exceed the motor's mechanical strength limits and the bearing limits so you should inquire to the motor's manufacturer about such operation.

#### Method of lubricating load mechanisms

Operating an oil-lubricated reduction gear and gear motor in the low-speed areas will worsen the lubricating effect. Check with the manufacturer of the reduction gear to find out about operable gearing area.

### Low loads and low inertia loads

The motor may demonstrate instability such as abnormal vibrations or overcurrent trips at light loads of 50% or under of the load percentage, or when the load's inertia moment is extremely small. If that happens reduce the carrier frequency.

### Occurrence of instability

Unstable phenomena may occur with the load and motor combinations shown below.

- Combined with a motor that exceeds applicable motor ratings for the inverter
- Combine with a much smaller motor according to the applicable motor rating of the inverter.
- Combined with special motors

To deal with the above lower the settings of inverter carrier frequency.

- Combined with couplings between load devices and motors with high backlash

When using the inverter in the above combination, use the S-pattern acceleration/deceleration function, or when vector control is selected, adjust the speed control response or switch to V/f control mode.

- Combined with loads that have sharp fluctuations in rotation such as piston movements

In this case, adjust the response time (inertial moment setting) during vector control or switch to V/f control.

### Braking a motor when cutting off power supply

A motor with its power cut off goes into free-run, and does not stop immediately. To stop the motor quickly as soon as the power is cut off install an auxiliary brake. There are different kinds of brake devices, both electrical and mechanical. Select the brake that is best for the system.

### Load that produces regenerative torque

When combined with a load that produces regenerative torque, the overvoltage or overcurrent protection function may be activated to trip the inverter.



## Motors with a brake

When motors with a brake are directly connected to the inverter's output, the brake cannot be released at startup because of low voltage. Wire the brake circuit separately from the main circuit.

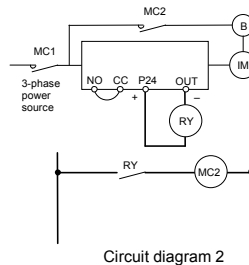
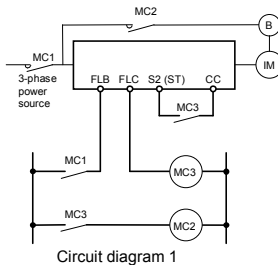

In circuit diagram 1, the brake is turned on and off through MC2 and MC3. If you do not wire it as shown in diagram 1, an over-current trip may occur because of a bound current during brake operation. (Example of running preparation ST assigned to terminal S2.)

In circuit diagram 2, the brake is turned on and off by using low-speed signal OUT.

In some situations, such as with elevators, turning the brake on and off with a low-speed signal may be appropriate. Be sure to contact us before designing your system.

## 1.4.2 Inverters

### Protecting inverters from overcurrent

The inverter has an overcurrent protection function. The programmed current level is set to the inverter's maximum applicable motor. If the motor used has a small capacity, the overcurrent level and the electronic thermal protection must be readjusted. If adjustment is necessary, refer to section 3.5, and make adjustments as directed.

### Inverter capacity

Do not use a small-capacity (kVA) inverter to control the operation of a large-capacity motor (two-class or more larger motor), no matter how light the load is. Current ripple will raise the output peak current making it easier to set off the overcurrent trip.

## Power factor correction capacitor

Power factor correction capacitors cannot be installed on the output side of the inverter. When a motor is run that has a power factor correction capacitor attached to it, remove the capacitors. This can cause inverter malfunction and capacitor destruction.

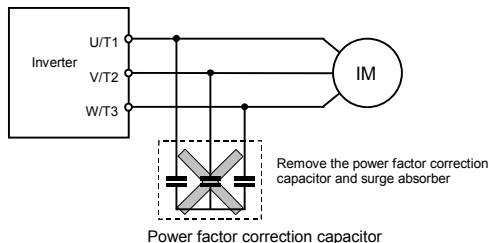

## Operating at other than rated voltage

Connections to voltages other than the rated voltage described in the rating label cannot be made. If a connection must be made to a power supply other than one with rated voltage, use a transformer to raise or lower the voltage to the rated voltage.

## Circuit breaking when two or more inverters are used on the same power line

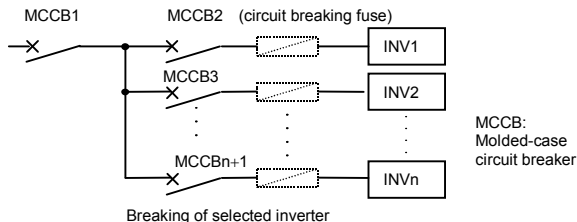

There is no fuse in the inverter's main circuit. Thus, as the diagram above shows, when more than one inverter is used on the same power line, you must select interrupting characteristics so that only MCCB2 to MCCBn+1 will trip and the MCCB1 will not trip when a short occurs in the inverter (INV1). When you cannot select the proper characteristics install a circuit interrupting fuse behind MCCB2 to MCCBn+1.

## If power supply distortion is not negligible

If the power supply distortion is not negligible because the inverter shares a power distribution line with other systems causing distorted waves, such as systems with thyristors or large-capacity inverters, install an input reactor to improve the input power factor, to reduce higher harmonics, or to suppress external surges.

## ■ Disposal

Refer to chapter 16.

### 1.4.3 What to do about the leakage current

#### ⚠ Caution



Mandatory  
action

Current may leak through the inverter's input/output wires because of insufficient electrostatic capacity on the motor with bad effects on peripheral equipment.  
The leakage current's value is affected by the carrier frequency and the length of the input/output wires.  
Test and adopt the following remedies against leak current.

#### (1) Leakage current from the inverter main unit

Some of these inverters are equipped with a ground capacitor compliant with the EMC directive which gives them a comparatively higher value than a normal inverter. Take this into consideration when selecting a leakage breaker.

Refer to "Leakage current" (E6581181) in the separate user manual for details.

#### (2) Influence of leakage current across ground

Leakage current may flow not just through the inverter system but also through ground wires to other systems. Leakage current will cause earth leakage breakers, leakage current relays, ground relays, fire alarms and sensors to operate improperly, and it will cause superimposed noise on the TV screen or display of incorrect current detection with the CT.

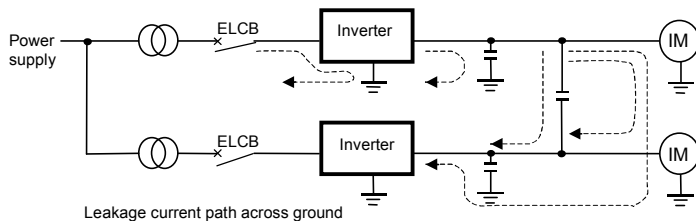

**Remedies:**

- 1.If there is no radio-frequency interference or similar problem, detach the built-in noise filter capacitor, using the grounding capacitor disconnecting switch. (Refer to section 1.3.3-2)
- 2.Reduce PWM carrier frequency.

The setting of PWM carrier frequency is done with the parameter  $F300$ .

- Although the electromagnetic noise level is reduced, the motor acoustic noise is increased.
3. Use high frequency remedial products for earth leakage breakers

1

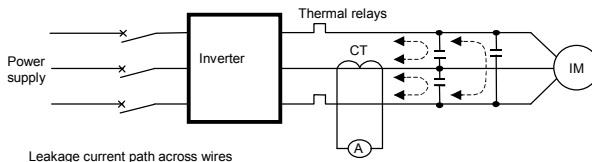
**(3) Influence of leakage current across lines****(1) Thermal relays**

The high frequency component of current leaking into electrostatic capacity between inverter output wires will increase the effective current values and make externally connected thermal relays operate improperly. If the wires are more than 50 meters long, it will be easy for the external thermal relay to operate improperly with models having motors of low rated current (several A(ampere) or less), because the leakage current will increase in proportion to the motor rating.

**Remedies:**

- 1.Use the electronic thermal built into the inverter. (Refer to section 3.5)

The setting of the electronic thermal is done using parameter  $OLn, tHr$ .

- 2.Reduce the inverter's PWM carrier frequency. However, that will increase the motor's magnetic noise.

The setting of PWM carrier frequency is done with the parameter  $F300$ . (Refer to section 6.11 in E6581595)

- 3.This can be improved by installing 0.1 $\mu$ ~0.5 $\mu$ F - 1000V film capacitor to the input/output terminals of each phase in the thermal relay.

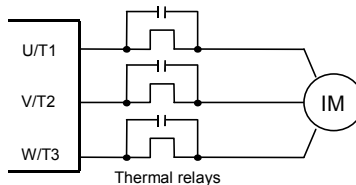

## (2) CT and ammeter

If a CT and ammeter are connected externally to detect inverter output current, the leak current's high frequency component may destroy the ammeter. If the wires are more than 50 meters long, it will be easy for the high frequency component to pass through the externally connected CT and be superimposed on and burn the ammeter with models having motors of low rated current (several A (ampere) or less), because the leakage current will increase in proportion to the motor's rated current.

## Remedies:

## 1. Use a meter output terminal in the inverter control circuit.

The load current can be output on the meter output terminal (FM). If the meter is connected, use an ammeter of 1mA<sub>dc</sub> full scale or a voltmeter of 10V full scale.

0-20mA<sub>dc</sub> (4-20mA<sub>dc</sub>) can be also output. (Refer to section 5.6 in E6581595)



## 2. Use the monitor functions built into the inverter.



Use the monitor functions on the panel built into the inverter to check current values. (Refer to section 8.2.1)

## 1.4.4 Installation

### ■ Installation environment

The VF-nC3 Inverter is an electronic control instrument. Take full consideration to installing it in the proper operating environment.

 <b>Warning</b>	
 Prohibited	<ul style="list-style-type: none"> <li>Do not place any inflammable substances near the VF-nC3 Inverter. If an accident occurs in which flame is emitted, this could lead to fire.</li> <li>Do not install in any location where the inverter could come into contact with water or other fluids. This can result in electric shock or fire.</li> </ul>
 Mandatory action	<ul style="list-style-type: none"> <li>Operate under the environmental conditions prescribed in the instruction manual. Operations under any other conditions may result in malfunction.</li> </ul>

 <b>Caution</b>	
 Prohibited	<ul style="list-style-type: none"> <li>Do not install the VF-nC3 Inverter in any location subject to large amounts of vibration. This could cause the unit to fall, resulting in bodily injury.</li> </ul>
 Mandatory action	<ul style="list-style-type: none"> <li>Check to make sure that the input power voltage is +10%, -15% of the rated power voltage written on the rating label (<math>\pm 10\%</math> when the load is 100% in continuous operation) If the input power voltage is not +10%, -15% of the rated power voltage (<math>\pm 10\%</math> when the load is 100% in continuous operation) this may result in fire.</li> </ul>



- Do not install in any location of high temperature, high humidity, moisture condensation and freezing and avoid locations where there is exposure to water and/or where there may be large amounts of dust, metallic fragments and oil mist.
- Do not install in any location where corrosive gases or grinding fluids are present.

- Operate in areas where ambient temperature ranges from -10°C to 60°C. Operation over 40°C is allowed when the top label is peeled off. When installing the inverter where the ambient temperature will rise above 50°C, remove the label (seal) from the top and operate it at a current lower than the rated one. (Refer to section 6.11 in E6581595)



[Position for measuring ambient temperature]

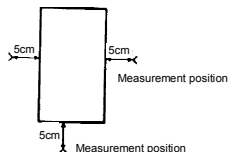

Note: The inverter is a heat-emitting body. Make sure proper space and ventilation is provided when installing in the cabinet. When installing inside a cabinet, we recommend the top seal peeled off although 40°C or less.

- Do not install in any location that is subject to large amounts of vibration.





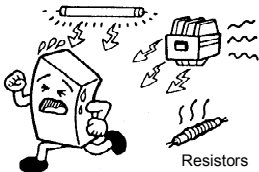

Note: If the VF-nC3 Inverter is installed in a location that is subject to vibration, anti-vibration measures are required. Please consult with Toshiba about these measures.

- If the VF-nC3 Inverter is installed near any of the equipment listed below, provide measures to insure against errors in operation.



- Solenoids: Attach surge suppressor on coil.
- Brakes: Attach surge suppressor on coil.
- Magnetic contactors: Attach surge suppressor on coil.
- Fluorescent lights: Attach surge suppressor on coil.
- Resistors: Place far away from VF-nC3 Inverter.

## ■ How to install

 <b>Warning</b>	
 Prohibited	<ul style="list-style-type: none"> <li>Do not install or operate the inverter if it is damaged or any component is missing. This can result in electric shock or fire. Please consult your local sales agency for repairs. Call your local sales agency for repairs.</li> </ul>
 Mandatory action	<ul style="list-style-type: none"> <li>Mount the inverter on a metal plate. The rear panel gets very hot. Do not install in an inflammable object, this can result in fire.</li> <li>Do not operate with the front panel cover removed. This can result in electric shock.</li> <li>An emergency stop device must be installed that fits with system specifications (e.g. shut off input power then engage mechanical brake). Operation cannot be stopped immediately by the inverter alone, thus risking an accident or injury.</li> <li>All options used must be those specified by Toshiba. The use of any other option may result in an accident.</li> </ul>
 <b>Caution</b>	
 Mandatory action	<ul style="list-style-type: none"> <li>The main unit must be installed on a base that can bear the unit's weight. If the unit is installed on a base that cannot withstand that weight, the unit may fall resulting in injury.</li> <li>If braking is necessary (to hold motor shaft), install a mechanical brake. The brake on the inverter will not function as a mechanical hold, and if used for that purpose, injury may result.</li> </ul>

### (1) Normal installation

Select an indoor location with good ventilation, and then install it upright on a flat metal plate.

When installing multiple inverters, leave at least 5 cm of space between each inverter and install them aligned horizontally.

When using the inverter in locations with temperatures above 40°C, remove the caution plate (sticker) on top of the inverter before use. Current reduction is necessary in locations that exceed 50°C.

### (2) Side-by-side installation

To align the inverters side-by-side horizontally, remove the caution plate (sticker) on top of the inverter before use. Current reduction is necessary in locations that exceed 40°C.

If the door is opened 90° or more, please open the door with the left side inverter's door open when the same capacity inverters are installed with side-by-side.

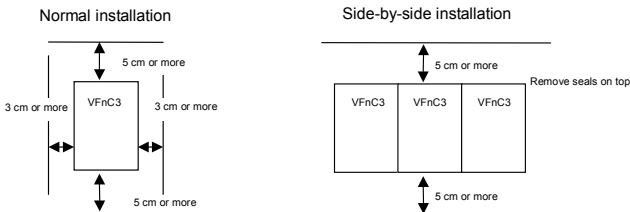

The space shown in the diagram is the minimum allowable space. Because air cooled equipment has cooling fans built in on the top or bottom surfaces, make the space on top and bottom as large as possible to allow for air passage.

Note: Do not install in any location where there is high humidity or high temperatures and where there are large amounts of dust, metallic fragments and oil mist.

## ■ Calorific values of the inverter and the required ventilation

About 5% of the rated power of the inverter will be lost as a result of conversion from AC to DC or from DC to AC. In order to suppress the rise in temperature inside the cabinet when this loss becomes heat loss, the interior of the cabinet must be ventilated and cooled.

The amount of forcible air-cooling ventilation required and the necessary heat discharge surface quantity when operating in a sealed cabinet according to capacity are as follows.

### Notes

- 1) Case of 100% Load Continuation operation. The heat loss for the optional external devices (input reactor, DC reactor, radio noise reduction filters, etc.) is not included in the calorific values.
- 2) It is power consumption when power is on but output frequency is 0Hz, and cooling fan is activated.

Voltage class	Inverter type	Calorific values Note 1)		Amount of forcible air cooling ventilation required (m <sup>3</sup> /min)		Heat discharge surface area required for sealed storage cabinet (m <sup>2</sup> )		Standby power requirement (W) Note 2)	
		4kHz	12kHz	4kHz	12kHz	4kHz	12kHz		
Three-phase 240V class	VFNC3-	2001P	13	14	0.07	0.08	0.26	0.28	8
		2002P	16	18	0.09	0.10	0.32	0.36	8
		2004P	24	28	0.14	0.16	0.48	0.56	8
		2007P	41	45	0.23	0.26	0.82	0.90	8
		2015P	73	85	0.41	0.48	1.46	1.70	12
		2022P	85	90	0.48	0.51	1.70	1.80	12
		2037P	128	133	0.73	0.75	2.56	2.66	12
Single-phase 240V class	VFNC3S-	2001PL	13	14	0.07	0.08	0.26	0.28	8
		2002PL	18	20	0.10	0.11	0.36	0.40	8
		2004PL	27	31	0.15	0.18	0.54	0.62	8
		2007PL	44	43	0.25	0.24	0.88	0.86	8
		2015PL	72	83	0.41	0.47	1.44	1.66	11
2022PL	93	102	0.53	0.53	1.86	2.04	11		
Single-phase 120V class	VFNC3S-	1001P	13	14	0.07	0.08	0.26	0.28	8
		1002P	18	20	0.10	0.11	0.36	0.40	8
		1004P	29	33	0.16	0.19	0.58	0.66	8
		1007P	48	54	0.27	0.31	0.96	1.08	11



## ■ Panel designing taking into consideration the effects of noise

The inverter generates high frequency noise. When designing the control panel setup, consideration must be given to that noise. Examples of measures are given below.

- Wire so that the main circuit wires and the control circuit wires are separated. Do not place them in the same conduit, do not run them parallel, and do not bundle them.
- Provide shielding and twisted wire for control circuit wiring.
- Separate the input (power) and output (motor) wires of the main circuit. Do not place them in the same conduit, do not run them parallel, and do not bundle them.
- Ground the inverter grounding terminals (⏚).
- Install surge suppressor on any magnetic contactor and relay coils used around the inverter.
- Install noise filters if necessary.
- To comply with the EMC directives, install the optional EMC plate and fix the shield to it.
- Install EMC plate and use shielded wires.

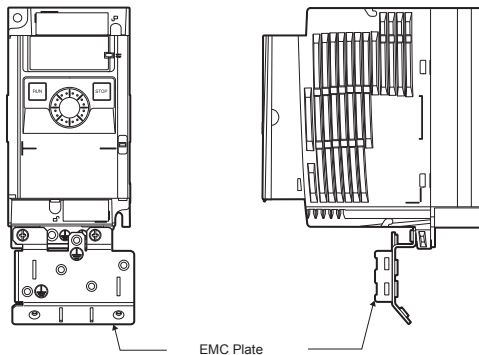



## ■ Installing more than one unit in a cabinet

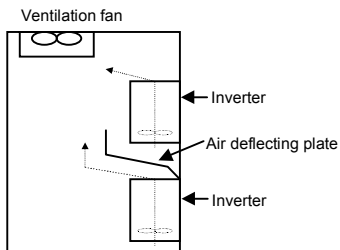

If you are installing two or more inverters in one cabinet, pay attention to the following.

- Inverters may be installed side by side with each other with no space left between them.
- When installing inverters side by side, detach the caution label on the top surface of each inverter and use them where the ambient temperature will not rise above 40°C.
- When using inverters where the ambient temperature will rise above 40°C, leave a space of 3 cm or more between them and remove the caution label from the top of each inverter, or operate each inverter at a current lower than the rated one.
- Ensure a space of at least 20 centimeters on the top and bottom of the inverters.
- Install an air deflecting plate so that the heat rising up from the inverter on the bottom does not affect the inverter on the top.





## 2. Connection

 <b>Warning</b>	
 Disassembly prohibited	<ul style="list-style-type: none"> <li>Never disassemble, modify or repair. This can result in electric shock, fire and injury. For repairs, call your sales agency.</li> </ul>
 Prohibited	<ul style="list-style-type: none"> <li>Don't stick your fingers into openings such as cable wiring hole and cooling fan covers. This can result in electric shock or other injury.</li> <li>Don't place or insert any kind of object into the inverter (electrical wire cuttings, rods, wires). This can result in electric shock or fire.</li> <li>Do not allow water or any other fluid to come in contact with the inverter. That may result in electric shock or fire.</li> </ul>

 <b>Caution</b>	
 Prohibited	<ul style="list-style-type: none"> <li>When transporting or carrying, do not hold by the front panel covers. The covers may come off and the unit will drop out resulting in injury.</li> </ul>

### 2.1 Cautions on wiring

 <b>Warning</b>	
 Prohibited	<ul style="list-style-type: none"> <li>Never remove the terminal cover when power is on or open door if enclosed in a cabinet. The unit contains many high voltage parts and contact with them will result in electric shock.</li> </ul>
 Mandatory action	<ul style="list-style-type: none"> <li>Turn power on only after attaching the front cover or closing door if enclosed in a cabinet. If power is turned on without the terminal cover attached or closing door if enclosed in a cabinet. This can result in electric shock or other injury.</li> <li>Electrical construction work must be done by a qualified expert. Connection of input power by someone who does not have that expert knowledge may result in fire or electric shock.</li> <li>Connect output terminals (motor side) correctly. If the phase sequence is incorrect, the motor will operate in reverse and that may result in injury.</li> <li>Wiring must be done after installation. If wiring is done prior to installation that may result in injury or electric shock.</li> <li>The following steps must be performed before wiring.             <ol style="list-style-type: none"> <li>(1) Shut off all input power.</li> <li>(2) Wait at least 15 minutes and check to make sure that the charge lamp is no longer lit.</li> <li>(3) Use a tester that can measure DC voltage (400VDC or more), and check to make sure that the voltage to the DC main circuits (across PA-PC) is 45V or less. If these steps are not properly performed, the wiring will cause electric shock.</li> </ol> </li> <li>Tighten the screws on the terminal board to specified torque. If the screws are not tightened to the specified torque, it may lead to fire.</li> </ul>

**Warning**

Be Grounded

- Ground must be connected securely.  
If the ground is not securely connected, it could lead to electric shock or fire when a malfunction or current leak occurs.

**Caution**

Prohibited

- Do not attach devices with built-in capacitors (such as noise filters or surge absorber) to the output (motor side) terminal.  
This could cause a fire.

**■ Preventing radio noise**

To prevent electrical interference such as radio noise, separately bundle wires to the main circuit's power terminals (3-phase models: R/L1, S/L2, T/L3, single-phase models: R/L1, S/L2/N) and wires to the motor terminals (U/T1, V/T2, W/T3).





**■ Control and main power supply**

The control power supply and the main circuit power supply for the VFnc3 are the same. If a malfunction or trip causes the main circuit to be shut off, control power will also be shut off. When checking the cause of the malfunction or the trip, use the trip holding retention selection parameter.

**■ Wiring**

- Because the space between the main circuit terminals is small use sleeved pressure terminals for the connections. Connect the terminals so that adjacent terminals do not touch each other.
- For ground terminal  use wires of the size that is equivalent to or larger than those given in table 10.1 and always ground the inverter (240V voltage class: D type ground).  
Use as large and short a ground wire as possible and wire it as close as possible to the inverter.
- For the sizes of electric wires used in the main circuit, refer to the table in section 10.1.
- The length of the main circuit wire in table 10.1 should be no longer than 30 meters. If the wire is longer than 30 meters, the wire size (diameter) must be increased.

## 2.2 Standard connections

 <b>Warning</b>	
 Prohibited	<ul style="list-style-type: none"> <li>Do not connect input power to the output (motor side) terminals (U/T1, V/T2, W/T3). Connecting input power to the output could destroy the inverter or cause a fire.</li> <li>Do not insert a resistor between DC terminals (between PA/+ and PC/-, or between PO and PC/-). It could cause a fire. See 6.13.4 for the connection of a resistor.</li> <li>First shut off input power and wait at least 15 minutes before touching wires on equipment (MCCB) that is connected to inverter power side. <u>Touching the wires before that time could result in electric shock.</u></li> </ul>
 Mandatory action	<ul style="list-style-type: none"> <li>Set a parameter <math>F\ 109</math> when VI terminal is used as logic input terminal. If it is not set, it could result in malfunction.</li> </ul>
 Be Grounded	<ul style="list-style-type: none"> <li>Ground must be connected securely. If the ground is not securely connected, it could lead to electric shock or fire when a malfunction or current leak occurs.</li> </ul>

## 2.2.1 Standard connection diagram 1

This diagram shows a standard wiring of the main circuit.

### Standard connection diagram - SINK (Negative) (common:CC)

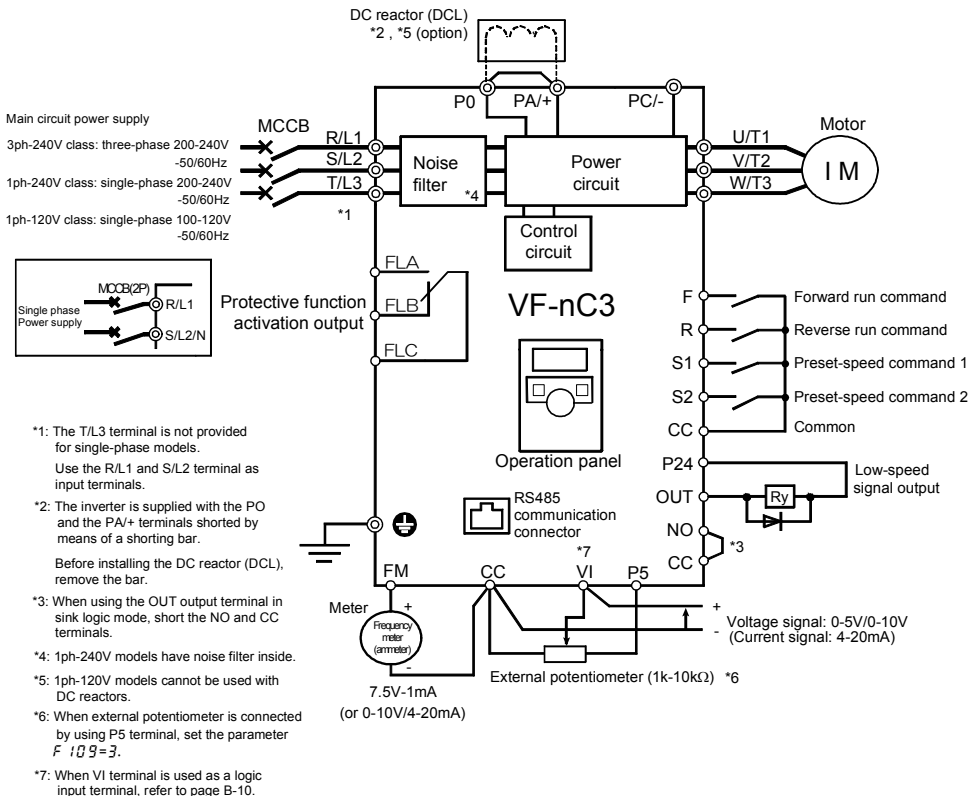

## 2.2.2 Standard connection diagram 2

Standard connection diagram - SOURCE (Positive) (common:P24)

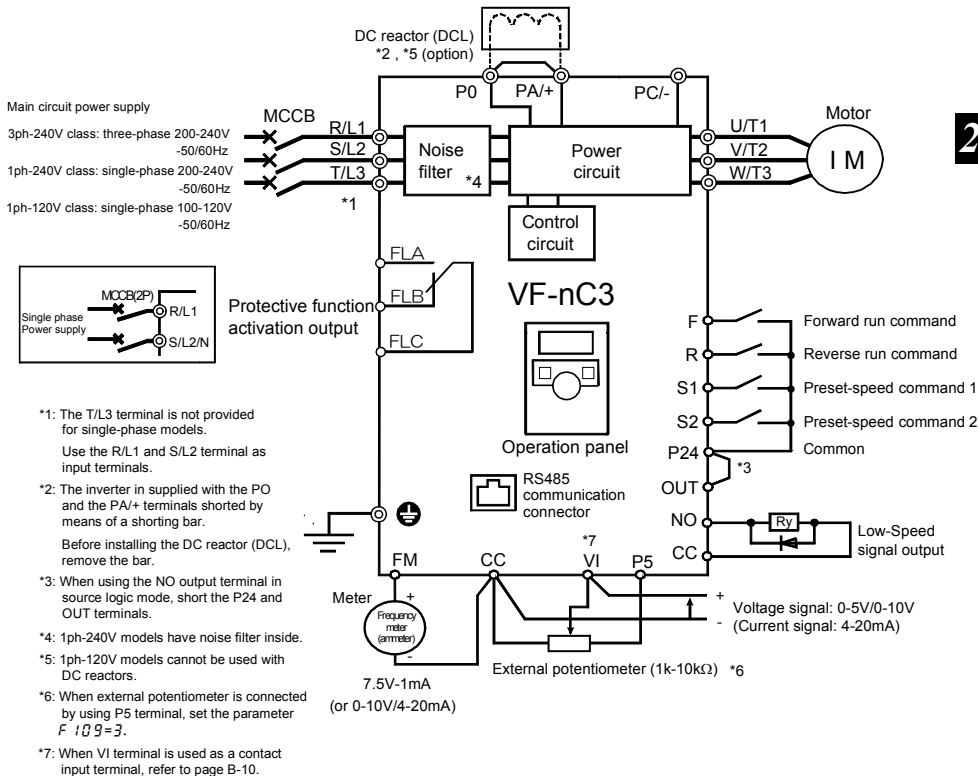

## 2.3 Description of terminals

### 2.3.1 Power circuit terminals

This diagram shows an example of wiring of the main circuit. Use options if necessary.

#### ■ Power supply and motor connections

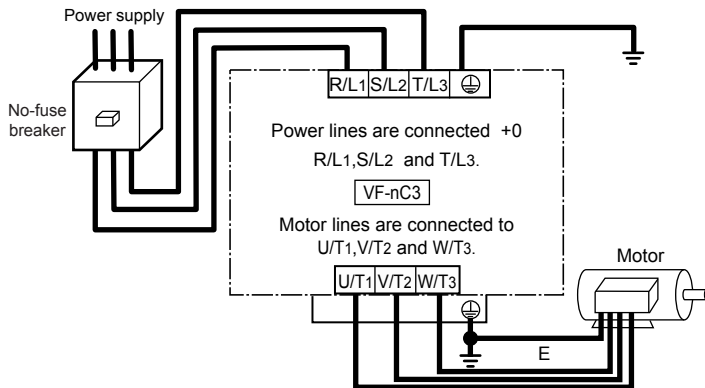

#### ■ Connections with peripheral equipment

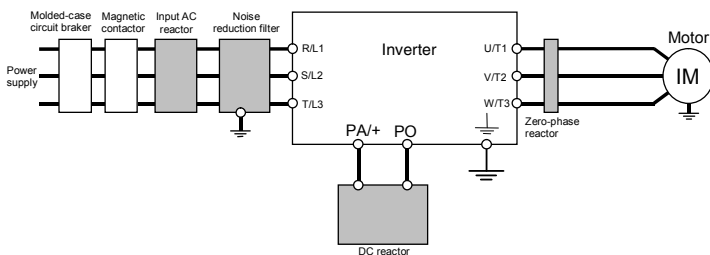

Note 1: The T/L3 terminal is not provided for any single-phase models. So if you are using single-phase models, use the R/L1 and S/L2/N terminals to connect power cables.



■ Power circuit

Terminal symbol	Terminal function
	Grounding terminal for connecting inverter. There are 4 terminals in total. (1 terminal on upper side, 3 terminals on down side)
R/L1,S/L2,T/L3	240V class: three-phase 200 to 240V-50/60Hz single-phase 200 to 240V-50/60Hz 120V class: single-phase 100 to 120V-50/60Hz * Single-phase input: R/L1 and S/L2/N terminals
U/T1,V/T2,W/T3	Connect to a (three-phase induction) motor.
PC/-	This is a negative potential terminal in the internal DC main circuit. DC common power can be input across the PA terminals (positive potential). DC common power can not connect to 1-phase 120V models.
PO, PA/+	Terminals for connecting a DC reactor (DCL: optional external device). Shorted by a short bar when shipped from the factory. Before installing DCL, remove the short bar. 1-phase 120V models cannot be used with DC reactors.

The arrangements of power circuit terminals are different from each range.

Refer to section 1.3.3.1) for details.

## 2.3.2 Control circuit terminals

The control circuit terminal board is common to all equipment.

Regarding to the function and specification of each terminal, please refer to the following table.

Refer to section 1.3.3.3) about the arrangement of control circuit terminals.

■ Control circuit terminals

Terminal symbol	Input / output	Function	Electrical specifications	Inverter internal circuits	
F	Input	Multifunction programmable logic input	No voltage logic input 24Vdc-5mA or less  *Sink/Source selectable using parameter $F_{i2}$  (In case of sink logic is the left)		
R	Input				Shorting across F-CC causes forward rotation; open causes slow-down and stop. (When Standby ST is always ON) 3 different functions can be assigned.
S1	Input				Shorting across R-CC causes reverse rotation; open causes slow-down and stop. (When Standby ST is always ON) 3 different functions can be assigned.
S2	Input				Shorting across S1-CC causes preset speed operation. 2 different functions can be assigned.
		Shorting across S2-CC causes preset speed operation. 2 different functions can be assigned.			

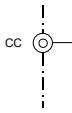
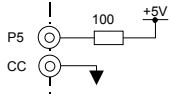
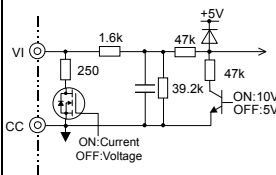
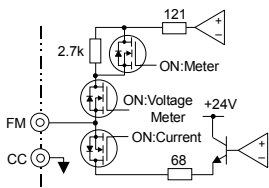
Terminal symbol	Input / output	Function	Electrical specifications	Inverter internal circuits
CC	Common to Input / output	Control circuit's equipotential terminal (2 terminals)		
P5	Output	Analog power supply output	5Vdc (permissible load current: 10mA)	
VI	Input	<p>Multifunction programmable analog input. Factory default setting: 0-10Vdc (1/1000 resolution) and 0-60Hz (0-50Hz) frequency input.</p> <p>The function can be changed to 0-20mAdc (4-20mA) current input by parameter <math>F109=1</math> setting.</p> <p>0-5Vdc (1/1000 resolution) voltage input by parameter <math>F109=3</math> setting. Switch to this setting when external potentiometer is connected by using P5 terminal.</p> <p>By changing parameter <math>F109=2</math> setting, this terminal can also be used as a multifunction programmable logic input terminal. When using the sink logic, be sure to insert a resistor between P24-VI (4.7 kΩ-1/2 W).</p>	<p>5V/10Vdc (internal impedance: 40kΩ)</p> <p>4-20mA (internal impedance: 250Ω) Note 1)</p>	
FM	Output	<p>Multifunction programmable analog output. Standard default setting: output frequency.</p> <p>The function can be changed to 0-10Vdc voltage or 0-20mAdc (4-20mA) current output by parameter <math>F581</math> setting.</p>	<p>1mAdc full-scale ammeter or QS60T (option)</p> <p>0-20mA (4-20mA) DC ammeter Permissible load resistance: 750Ω or less</p> <p>0-10V DC volt meter Permissible load resistance: 1kΩ or more</p>	

Note 1) Be careful, if 4-20mA is selected, when the inverter's power is ON, the internal impedance is 250Ω, but when the power is OFF, the internal impedance increases very much to approximately 40kΩ.

Terminal symbol	Input / output	Function	Electrical specifications	Inverter internal circuits
P24	Output	24Vdc power output	24Vdc-100mA	
	Input	This terminal can be used as an external 24Vdc input for logic input terminal by changing parameter $F 1 2 7=2 0 0$ .	-	
OUT NO	Output	Multifunction programmable open collector output. Standard default setting detect and output low speed signal. Multifunction output terminals to which two different functions can be assigned. The NO terminal is an isoelectric output terminal. It is insulated from the CC terminal.  By changing parameter settings, these terminals can also be used as multifunction programmable pulse train output terminals.	Open collector output 24Vdc-100mA  To output pulse trains, a current of 10mA or more needs to be passed.  Pulse frequency range: 38~1600pps	
FLA FLB FLC  Note 2)	Output	Multifunction programmable relay contact output. Detects the operation of the inverter's protection function. Contact across FLA-FLC is closed and FLB-FLC is opened during protection function operation.	Max. switching capacity 250Vac-2A 30Vdc-2A ( $\cos\phi=1$ ) : at resistive load  250Vac-1A ( $\cos\phi=0.4$ ) 30Vdc-1A (L/R=7ms)  Min. permissible load 5Vdc-100mA 24Vdc-5mA	

Note 2) A chattering (momentary ON/OFF of contact) is generated by external factors of the vibration and the impact, etc. In particular, please set the filter of 10ms or more, or timer for measures when connecting it directly with input unit terminal of programmable controller. Please use the OUT terminal as much as possible when the programmable controller is connected.

## ■ SINK (Negative) logic/SOURCE (Positive) logic (When the inverter's internal power supply is used)

Current flowing out turns control input terminals on. These are called sink logic terminals.

The general used method in Europe is source logic in which current flowing into the input terminal turns it on.

Sink logic is sometimes referred to as negative logic, and source logic is referred to as positive logic.

Each logic is supplied with electricity from either the inverter's internal power supply or an external power supply, and its connections vary depending on the power supply used.

Setting of sink/source logic varies depending on the setup menu setting. (Refer to section 11.5)

Sink/source logic can be switched by parameter  $F_{127}$ .

<Examples of connections when the inverter's internal power supply is used>

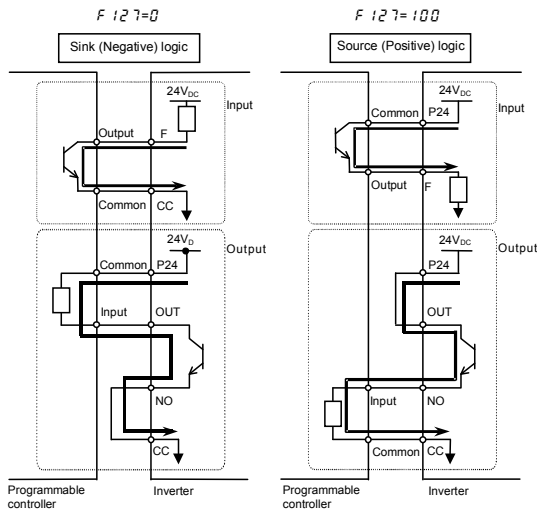

■ SINK (Negative) logic (When an external power supply is used)

The P24 terminal is used to connect to an external power supply or to separate a terminal from other input or output terminals.

<Examples of connections when an external power supply is used>

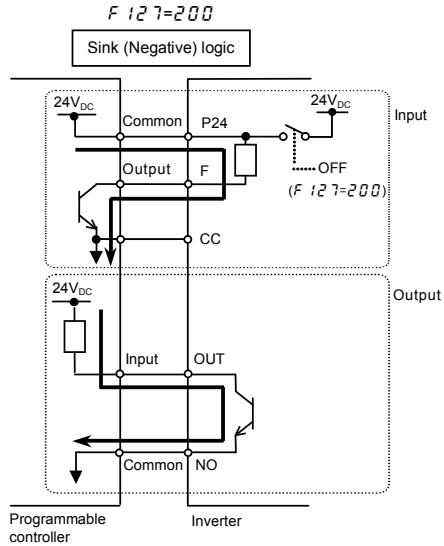

## ■ Selecting the functions of the VI terminal between analog input and logic input

The functions of the VI terminal can be selected between analog input and logic input by changing parameter settings ( $F$   $\uparrow$   $\downarrow$   $\mathcal{G}$ ). (Factory default setting: Analog input 0-10V)

Be sure to connect a resistor between P24 and VI terminals in case of sink logic, between VI and CC terminals in case of source logic. (Recommended resistance:  $4.7k\Omega$ -1/2W)

When using VI terminal as a logic input terminal, set the parameter  $F$   $\uparrow$   $\downarrow$   $\mathcal{G}$ =2 and connect as following schematics.

If no resistor is inserted, logic input will be left always ON, which is very dangerous.

Switch between analog input and logic input before connecting the terminals to the control circuit terminals.

Otherwise the inverter or devices connected to it may be damaged.

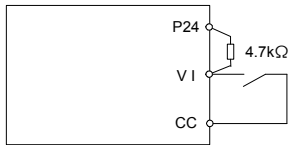

<Sink logic>



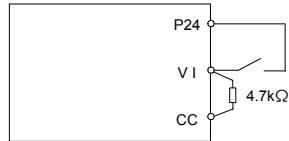

<Source logic>



### 3. Operations

 <b>Caution</b>	
 Prohibited	<ul style="list-style-type: none"> <li>Do not touch inverter terminals when electrical power is going to the inverter even if the motor is stopped. Touching the inverter terminals while power is connected to it may result in electric shock.</li> <li>Do not touch switches when the hands are wet and do not try to clean the inverter with a damp cloth. Such practices may result in electric shock.</li> <li>Do not go near the motor in alarm-stop status when the retry function is selected. The motor may suddenly restart and that could result in injury. Take measures for safety, e.g. attaching a cover to the motor, against accidents when the motor unexpectedly restarts.</li> </ul>
 Mandatory action	<ul style="list-style-type: none"> <li>If the inverter begins to emit smoke or an unusual odor, or unusual sounds, immediately turn power off. If the equipment is continued in operation in such a state, the result may be fire. Call your local sales agency for repairs.</li> <li>Always turn power off if the inverter is not used for long periods of time.</li> <li>Turn the input power on only after attaching the terminal block cover. When enclosed inside a cabinet and used with the terminal block cover removed, always close the cabinet doors first and then turn the power on. If the power is turned on with the terminal block cover or the cabinet doors open, this may result in electric shock.</li> <li>Make sure that operation signals are off before resetting the inverter after malfunction. If the inverter is reset before turning off the operating signal, the motor may restart suddenly causing injury.</li> </ul>

 <b>Caution</b>	
 Contact prohibited	<ul style="list-style-type: none"> <li>Do not touch heat radiating fins or discharge resistors. These devices are hot, and you'll get burned if you touch them.</li> </ul>
 Prohibited	<ul style="list-style-type: none"> <li>Observe all permissible operating ranges of motors and mechanical equipment. (Refer to the motor's instruction manual.) Not observing these ranges may result in injury.</li> </ul>

## 3.1 How to Set the Setup Menu

### Warning





Mandatory  
action

- If incorrect setting, the drive may have some damage or unexpected movement. Be sure to set the setup parameter correctly.

Set the setup menu according to the logic for control input signals used and the base frequency of the motor connected. (If you are not sure which setup menu should be selected region codes and what values should be specified, consult your distributor.)

Each setup menu automatically sets all parameters relating to the logic for control input signals used and the base frequency of the motor connected. (See the table on the following page.)

Follow these steps to change the setup menu [Example: Selecting a region code to *EU*]

Panel operated	LED display	Operation				
	<i>SEt</i>	Power on. ( <i>SEt</i> is blinking)				
	<table border="1" style="margin-left: auto; margin-right: auto;"> <tr> <td><i>EU</i></td> <td><i>JP</i></td> </tr> <tr> <td><i>RSIA</i></td> <td><i>USA</i></td> </tr> </table>	<i>EU</i>	<i>JP</i>	<i>RSIA</i>	<i>USA</i>	Turn the setting dial, and select region code " <i>EU</i> " (Europe).
<i>EU</i>	<i>JP</i>					
<i>RSIA</i>	<i>USA</i>					
	<i>EU &lt;=&gt; in it</i>	Press the center of the setting dial to determine the region.				
	<i>0.0</i>	The operation frequency is displayed (Standby).				

☆ When changing the region selected in the setup menu, the setup menu can be called again by the following method. Note, however, that all parameter settings return to standard defaults.

- Set parameter *tYP* to "*13*".
- Set parameter *SEt* to "*0*".

☆ The parameter settings in the table on the following page can be changed individually even after they are selected in the setup menu.

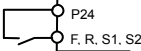
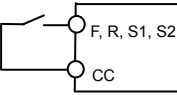

## ■ Values set by each setup parameter

Title	Function	<i>EU</i> (Mainly in Europe)	<i>USA</i> (Mainly in North America)	<i>RSIA</i> (Mainly in Asia, Oceania)	<i>JP</i> (Mainly in Japan)
<i>FH</i>	Maximum frequency	50.0(Hz)	60.0(Hz)	50.0(Hz)	80.0(Hz)
<i>UL / UL / F170</i>	Frequency settings	50.0(Hz)	60.0(Hz)	50.0(Hz)	60.0(Hz)
<i>F204</i>	VI input point 2 frequency	50.0(Hz)	60.0(Hz)	50.0(Hz)	60.0(Hz)
<i>ULU / F171</i>	Base frequency voltage 1, 2	230(V)	230(V)	230(V)	200(V)
<i>F127</i>	Sink/source switching	100 [ Source logic ] (Positive common) (Common : P24) 	0 [ Sink logic ] (Negative common) (Common : CC) 		
<i>F307</i>	Supply voltage correction (output voltage limitation)	2	2	2	3
<i>F477</i>	Motor rated speed	1410(min <sup>-1</sup> )	1710(min <sup>-1</sup> )	1410(min <sup>-1</sup> )	1710(min <sup>-1</sup> )

## 3.2 Simplified Operation of the VF-nC3

The procedures for setting operation frequency and the methods of operation can be selected from the following.

Run / Stop : (1) Run and stop using the panel keypad  
(2) Run and stop using external signals to terminal board

Setting the frequency : (1) Setting using setting dial  
(2) Setting using external signals to terminal board (0-5V/0-10Vdc, 4-20mAdc)

Use the basic parameters  $\text{CnQd}$  (command mode selection)  $\text{FnQd}$  and (frequency setting mode selection) for selection.

[Parameter setting]





Title	Function	Adjustment range	Default setting
$\text{CnQd}$	Command mode selection	0: Terminal board 1: Panel keypad (including extension panel) 2: RS485 communication	1
$\text{FnQd}$	Frequency setting mode selection	0: Terminal board VI 1: Setting dial 1 (press in center to save) 2: Setting dial 2 (save even if power is off) 3: RS485 communication 4: - 5: UP/DOWN form external logic input	2

☆  $\text{FnQd}=2$  (setting dial 2) is the mode where after the frequency is set by the setting dial, the frequency is saved even if the power is turned off.

☆ Refer to section 5.5 in E6581595 for details about  $\text{FnQd}=3$  and 5.

### 3.2.1 How to run and stop

[Example of a  $\text{C} \text{R} \text{O} \text{d}$  setting procedure]

Panel operation	LED display	Operation
	0.0	Displays the operation frequency (operation stopped). (When standard monitor display selection $F \ 7 \ 1 \ 0 = 0$ (Operation frequency))
	RUH	Displays the first basic parameter [History (RUH)].
	$\text{C} \ \text{R} \ \text{O} \ \text{d}$	Turn the setting dial, and select " $\text{C} \ \text{R} \ \text{O} \ \text{d}$ ".
	!	Press the center of the setting dial to read the parameter value. (Standard default: !).
	0	Turn the setting dial to change the parameter value to 0 (terminal block).
	$0 \leftrightarrow \text{C} \ \text{R} \ \text{O} \ \text{d}$	Press the center of the setting dial to save the changed parameter. $\text{C} \ \text{R} \ \text{O} \ \text{d}$ and the parameter set value are displayed alternately.

#### (1) Run and stop using the panel keypad ( $\text{C} \ \text{R} \ \text{O} \ \text{d} = !$ )

Use the **RUN** and **STOP** keys on the panel keypad to start and stop the motor.

**RUN** : Motor runs.      **STOP** : Motor stops.

- ★ The direction of rotation is determined by the setting of parameter  $F \ r$  (forward run, reverse run selection). (0: forward run, 1: reverse run)
- ★ To switch between forward run and reverse run from the extension panel (option), the parameter  $F \ r$  (forward run, reverse run selection) needs to be set to 2 or 3. (Refer to section 5.7 in E6581595)

#### (2) RUN / STOP by means of an external signal to the terminal board ( $\text{C} \ \text{R} \ \text{O} \ \text{d} = 0$ ): Sink (Negative) logic

Use external signals to the inverter terminal board to start and stop the motor.

Short **F** and **CC** terminals: run forward

Open **F** and **CC** terminals: slow down and stop

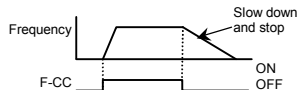

### (3) Coast stop

The standard default is slowdown stop. To make a coast stop, assign "6 (ST)" to an idle terminal.  
Change to  $F 1 1 \bar{Q} = \bar{Q}$ .

For coast stop, open the ST-CC when stopping the motor in the state described at left. The monitor on the inverter at this time will display  $\bar{Q} F F$ .

A coast stop can also be made by assigning "9 6 (FRR)" to an idle terminal.

When doing this, a coast stop is done by FRR and CC both turning on.

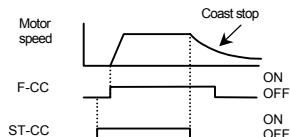

## 3.2.2 How to set the frequency

[Example of  $F \bar{N} \bar{Q} d$  setting procedure]: Setting the frequency setting destination to the terminal block

Panel operation	LED display	Operation
	$\bar{Q} \bar{Q}$	Displays the operation frequency (operation stopped). (When standard monitor display selection $F 7 1 \bar{Q} = \bar{Q}$ [Operation frequency])
	$R U H$	Displays the first basic parameter [History ( $R U H$ )].
	$F \bar{N} \bar{Q} d$	Turn the setting dial, and select " $F \bar{N} \bar{Q} d$ ".
	$\bar{2}$	Press the center of the setting dial to read the parameter value. (Standard default: $\bar{2}$ ).
	$\bar{Q}$	Turn the setting dial to change the parameter value to $\bar{Q}$ (terminal block VI).
	$\bar{Q} \Rightarrow F \bar{N} \bar{Q} d$	The parameter value is written. $F \bar{N} \bar{Q} d$ and the parameter value are displayed alternately several times.

\* Pressing the MODE key twice returns the display to standard monitor mode (displaying operation frequency).

### (1) Setting using the keypad ( $F \bar{N} \bar{Q} d = 1$ or $\bar{2}$ )



: Moves the frequency up



: Moves the frequency down

### ■ Example of operating from the panel ( $F \bar{N} \bar{Q} d = 1$ : press in center to save)

Panel operation	LED display	Operation
	$\bar{Q} \bar{Q}$	Displays the operation frequency. (When standard monitor display selection $F 7 1 \bar{Q} = \bar{Q}$ [Operation frequency])
	$5 \bar{Q} \bar{Q}$	Set the operation frequency. (The frequency will not be saved if the power is turned off in this state.)
	$5 \bar{Q} \bar{Q} \Rightarrow F \bar{C}$	Save the operation frequency. $F \bar{C}$ and the frequency are displayed alternately.

■ Example of operating from the panel (*F70d=2*: save even if power is off)

Panel operation	LED display	Operation
	0.0	Display the operation frequency. (When standard monitor display selection is set as <i>F710=0</i> [operation frequency])
	60.0	Set the operation frequency.
-	60.0	The frequency will be saved even if the power is turned off in this state.

(2) Setting of frequency using external signals to terminal block ( $FND=0$ )

## ■ Frequency setting

## 1) Setting the frequency using external potentiometer

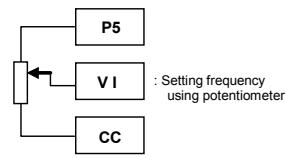

★Potentiometer  
Setting frequency using the potentiometer (1-10k $\Omega$ , 1/4W)  
Refer to section 6.5.2 in E6581595 for detailed adjustment.

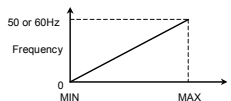

Note) Set parameter  $F109=3$ .

## 2) Setting the frequency using voltage input (0-10V)

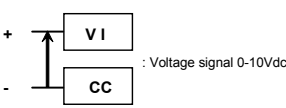

★Voltage signal  
Setting frequency using voltage signals (0-10V).  
Refer to section 6.5.2 in E6581595 for detailed adjustment.

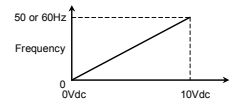

Note) Set parameter  $F109=0$ .

## 3) Setting the frequency using current input (4-20mA)

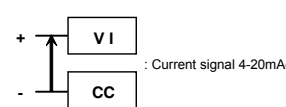

★Current signal  
Current signal Setting frequency using current signals (4-20mA).  
Refer to section 6.5.2 in E6581595 for detailed adjustment.

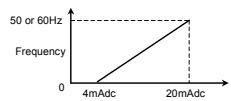

\* Setting of parameters also allow 0-20mA dc.  
Note) Set parameter  $F109=1$  and  $F201=20$ .

## 4) Setting the frequency using voltage input (0-5V)

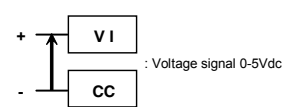

★Voltage signal  
Set the frequency using voltage signals (0-5V).  
Refer to section 6.5.2 in E6581595 for detailed adjustment.

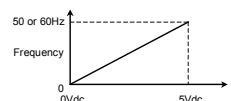

Note) Set parameter  $F109=3$ .

### 3.3 How to operate the VF-nC3

Overview of how to operate the inverter with simple examples.

**Ex.1**

Setting the frequency using the setting dial, and run/stop using the panel keypad (1)

(1) Wiring

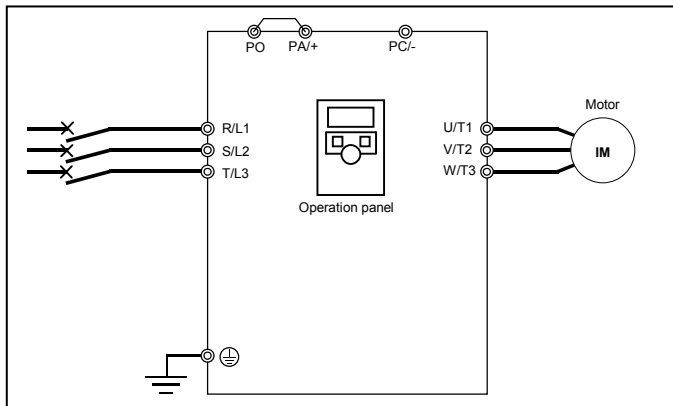

(2) Parameter setting (default setting)

Title	Function	Programmed value
<i>f P d</i>	Command mode selection	1
<i>F P d</i>	Frequency setting mode selection	2

(3) Operation

Run/stop: Press the  and  keys on the panel.

Frequency setting: Turn the setting dial to set the frequency. The frequency setting is saved just by turning the setting dial.

## Ex.2

Setting the frequency using the setting dial, and run/stop using the panel keypad (2)

## (1) Wiring

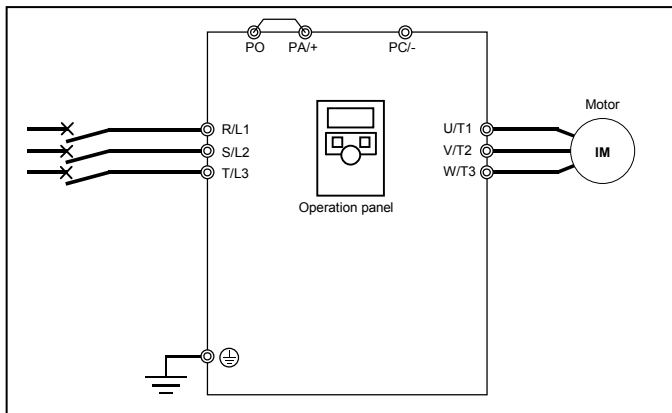

## (2) Parameter setting

Title	Function	Programmed value
$\overline{C} \overline{M} \overline{D}$	Command mode selection	1
$\overline{F} \overline{M} \overline{D}$	Frequency setting mode selection	1

## (3) Operation

Run/stop: Press the **RUN** and **STOP** keys on the panel.

Frequency setting: Turn the setting dial to set the frequency.

To save the frequency setting, press the center of the setting dial.

$\overline{F} \overline{C}$  and the set frequency will flash on and off alternately.



**Ex.3**

Setting the frequency using the setting dial, and run/stop using external signals

## (1) Wiring

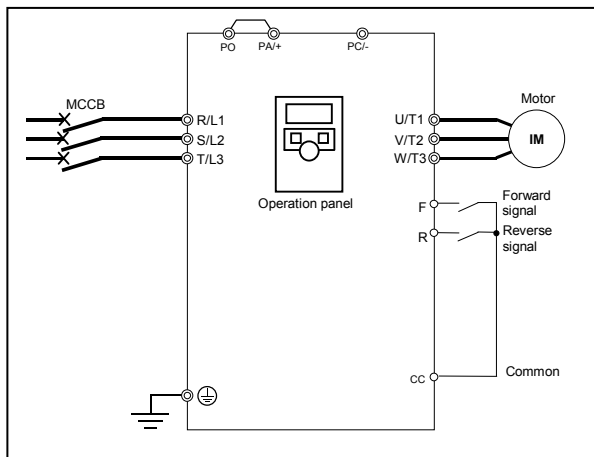

## (2) Parameter setting

Title	Function	Programmed value
<i>C M d</i>	Command mode selection	0
<i>F N d</i>	Frequency setting mode selection	1 or 2

## (3) Operation

Run/stop: ON/OFF input to F-CC, R-CC. (with sink logic)

Frequency setting: Turn the setting dial to set the frequency.

## Ex.4

Setting the frequency using external signals, run/stop using external signals.

## (1) Wiring

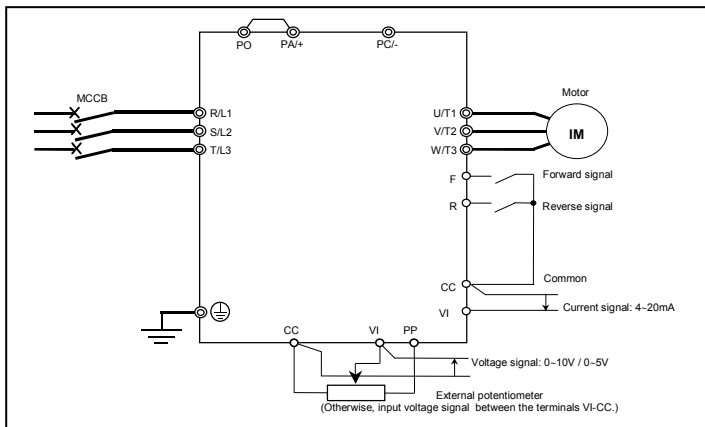

## (2) Parameter setting

Title	Function	Programmed value
<i>F00d</i>	Command mode selection	0
<i>F00d</i>	Frequency setting mode selection	0

## (3) Operation

Run/stop: ON/OFF input to F-CC, R-CC. (with sink logic)

Frequency setting: VI: Input 0-10Vdc (external potentiometer) or 4-20mA to set the frequency.

\* Set the voltage/current input of VI in parameter *F109*.

0: Voltage signal input (0-10V)

1: Current signal input (4-20mA)

3: Voltage signal input (0-5V), when the P5 terminal is connected and the external potentiometer is used

## 3.4 Meter setting and adjustment

***F $\bar{N}$ SL***: Meter selection

***F $\bar{N}$*** : Meter adjustment gain

- Function  
Output of 0 - 1mAdc, 0 (4) - 20mAdc, 0 - 10vdc can be selected for the output signal from the FM terminal, depending on the *F $\bar{B}$ B* setting. Adjust the scale at *F $\bar{N}$* .  
Use an ammeter with a full-scale 0 - 1mAdc meter.  
The *F $\bar{B}$ Q* (analog output bias) needs to be adjusted if output is 4 - 20mAdc.

[Parameter setting]

Title	Function	Adjustment range	Supposition output at <i>F<math>\bar{N}</math>SL = 17</i>	Default setting
<i>F<math>\bar{N}</math>SL</i>	Meter selection	0: Output frequency 1: Output current 2: Frequency reference 3: Input voltage (DC detection) 4: Output voltage (command value) 5 to 11: - 12: Frequency setting value (after compensation) 13: VI input value 14: - 15: Fixed output 1 (output current 100% equivalent) 16: Fixed output 2 (output current 50% equivalent) 17: Fixed output 3 (other than the output current) 18: RS485 communication data 19: For adjustments ( <i>F<math>\bar{N}</math></i> set value is displayed.) 20 to 22: -	Maximum frequency ( <i>F<math>\bar{H}</math></i> ) - Maximum frequency ( <i>F<math>\bar{H}</math></i> ) 1.5x rated voltage 1.5x rated voltage - Maximum frequency ( <i>F<math>\bar{H}</math></i> ) - Maximum input value - - - Maximum value (100.0%) - -	0
<i>F<math>\bar{N}</math></i>	Meter adjustment gain	-	-	-

- Resolution  
All FM terminals have a maximum of 1/255.
- Example of 4-20mA output adjustment (Refer to section 6.17.2 for details)

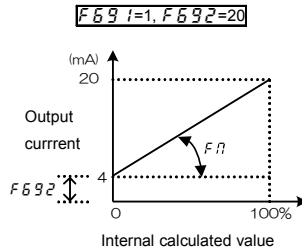
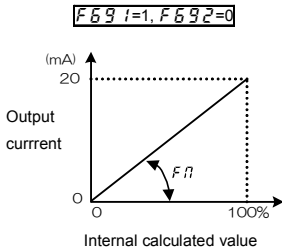

Note 1) When using the FM terminal for current output, be sure that the external load resistance is less than 750Ω.

Use at over 1kΩ external load resistance, if used for voltage output.



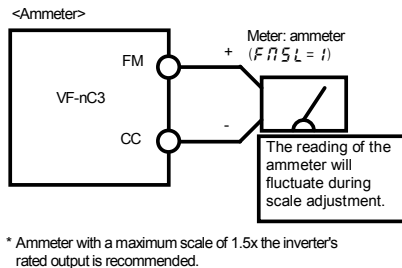
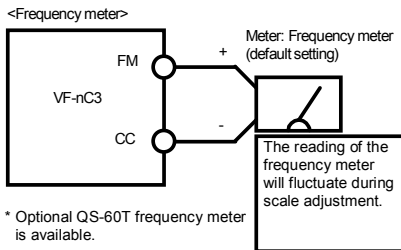

Note 2)  $F\dot{\eta}5L = f$  is the motor drive frequency.

- Adjustment scale with parameter  $F\dot{\eta}$  (Meter adjustment)  
Connect meters as shown below.



[Example of how to adjustment the FM terminal frequency meter]

\* Use the meter's adjustment screw to pre-adjust zero-point.

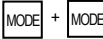
Operation panel action	LED display	Operation
-	60.0	Displays the output frequency. (When standard monitor display selection $F710$ is set to 0)
	RUH	The first basic parameter "RUH" (history function) is displayed.
	FN	Turn the setting dial to select FN.
	60.0	Operation frequency can be read by pressing the center of the setting dial.
	60.0	Turn the setting dial to adjust the meter. Note that the meter's indicator changes at this time, but the inverter's display (monitor) does not change.
	60.0 ⇄ FN	Press the center of the setting dial to save the meter's calibrations. FN and the frequency are displayed alternately.
	60.0	The display returns to its original indications. (When standard monitor display selection $F710$ is set to 0 [Operation frequency])

## ■ Adjusting the meter in inverter stop state

- Adjustment of output current ( $FN5L = 1$ )

If, when adjusting the meter for output current, there are large fluctuations in data during adjustment, making adjustment difficult, the meter can be adjusted in inverter stop state.

When setting  $FN5L$  to 15 for fixed output 1 (output current 100% equivalent), a signal of absolute values will be output (inverter's rated current = 100%). In this state, adjust the meter with the FN (Meter adjustment) parameter.

Similarly, if you set  $FN5L$  to 16 for fixed output 2 (output current 50% equivalent), a signal that is sent out when half the inverter's rated current is flowing will be output through the FM terminal.

After meter adjustment is ended, set  $FN5L$  to 1 (output current).

- Other adjustments ( $FN5L = 0, 2 - 4, 12, 13, 18$ )

$FN5L = 17$ : When fixed output 3 (other than the output current) is set, a signal of the value for other monitors is fixed at the following values and output through the FM terminal.

100% standard value for each item is the following:

$FN5L = 0, 2, 12$  : Maximum frequency (FH)

$FN5L = 3, 4$  : 1.5 times of rated voltage

$FN5L = 13$  : Maximum input value (5V, 10V, or 20mA)

$FN5L = 18$  : Maximum value (1000)

### 3.5 Setting the electronic thermal

**EHr** : Motor electronic-thermal protection level 1

**OLn** : Electronic-thermal protection characteristic selection

**F173** : Motor electronic-thermal protection level 2

**F607** : Motor 150% overload detection time

**F632** : Electronic-thermal memory

- Function

This parameter allows selection of the appropriate electronic thermal protection characteristics according to the particular rating and characteristics of the motor.

[Parameter setting]

Title	Function	Adjustment range				Default setting
<b>EHr</b>	Motor electronic-thermal protection level 1	10 – 100 (%) / (A) *1				100
<b>OLn</b>	Electronic-thermal protection characteristic selection	Setting value		Overload protection	Overload stall	0
		0	Standard motor	valid	invalid	
		1		valid	valid	
		2		invalid	invalid	
		3		invalid	valid	
		4	VF motor (special motor)	valid	invalid	
		5		valid	valid	
		6		invalid	invalid	
7	invalid	valid				
<b>F173</b>	Motor electronic-thermal protection level 2	10 – 100 (%) / (A) *1				100
<b>F607</b>	Motor 150% overload detection time	10 – 2400 (s)				300
<b>F632</b>	Electronic-thermal memory	0: Disabled 1: Enabled *2				0

\*1: The inverter's rated current is 100%. When **F707** (current and voltage unit selection) = 1 (A (amps)/V (volts)) is selected, it can be set at A (amps).

\*2: The thermal status (overload totaling level) of the inverter or motor is saved when the power is turned off, and is calculated when the power is turned on from the off status.

Note: **F637** is a parameter for manufacturer settings. Do not change this parameter.

- 1) Setting the electronic thermal protection characteristics selection  $\boxed{0L1}$  and motor electronic thermal protection level 1  $\boxed{tHr}$ , 2  $\boxed{F173}$

The electronic thermal protection characteristics selection  $\boxed{0L1}$  is used to enable or disable the motor overload trip function ( $\boxed{0L2}$ ) and the overload stall function.

While the inverter overload trip ( $\boxed{0L1}$ ) will be in constant detect operation, the motor overload trip ( $\boxed{0L2}$ ) can be selected using the parameter  $\boxed{0L1}$ .

#### Explanation of terms

**Overload stall:** This is an optimum function for equipment such as fans, pumps and blowers with variable torque characteristics that the load current decreases as the operating speed decreases.

When the inverter detects an overload, this function automatically lowers the output frequency before the motor overload trip  $\boxed{0L2}$  is activated. With this function, operation can be continued, without tripping, by operating using a frequency balanced by load current.

**Note:** Do not use the overload stall function with loads having constant torque characteristics (such as conveyor belts in which load current is fixed with no relation to speed).

#### [Using standard motors (other than motors intended for use with inverters)]

When a motor is used in the lower frequency range than the rated frequency, that will decrease the cooling effects for the motor. This speeds up the start of overload detection operations when a standard motor is used in order to prevent overheating.

#### ■ Setting of electronic thermal protection characteristics selection $\boxed{0L1}$

Setting value	Overload protection	Overload stall
$\boxed{0}$	valid	invalid
$\boxed{1}$	valid	valid
$\boxed{2}$	invalid	invalid
$\boxed{3}$	invalid	valid

#### ■ Setting of motor electronic thermal protection level 1 $\boxed{tHr}$ (Same as $\boxed{F173}$ )

When the capacity of the motor in use is smaller than the capacity of the inverter, or the rated current of the motor is smaller than the rated current of the inverter, adjust thermal protection level 1  $\boxed{tHr}$  for the motor in accordance with the motor's rated current.

\* When displaying as a percentage, 100% = rated output current (A) of the inverter is displayed.

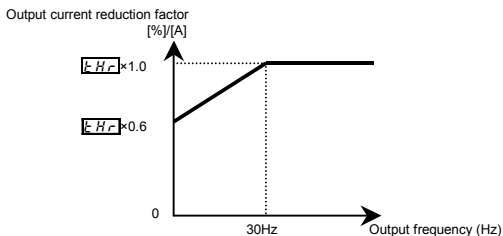

Note: The motor overload protection start level is fixed at 30Hz.

[Example of setting: When the VFNC3-2007P is running with a 0.4kW motor having 2A rated current]

Operation panel action	LED display	Operation
	0.0	Displays the operation frequency. (Perform during operation stopped.) (When standard monitor display selection $F 7 10$ is set to 0 [Operation frequency])
	RUH	The first basic parameter "RUH" (history function) is displayed.
	$\epsilon H_r$	Turn the setting dial to change the parameter to $\epsilon H_r$ .
	100	Parameter values can be read by pressing the center of the setting dial (default setting is 100%).
	48	Turn the setting dial to change the parameter to 48% (= motor rated current/inverter output rated current $\times 100=2.0/4.2 \times 100$ )
	$48 \leftrightarrow \epsilon H_r$	Press the center of the setting dial to save the changed parameter. $\epsilon H_r$ and the parameter are displayed alternately.

Note: The rated output current of the inverter should be calculated from the rated current for frequencies below 4kHz, regardless of the setting of the PWM carrier frequency parameter ( $F 300$ ).

[Using a VF motor (motor for use with inverter)]

#### ■ Setting of electronic thermal protection characteristics selection $0 L 7$

Setting value	Overload protection	Overload stall
4	valid	invalid
5	valid	valid
6	invalid	invalid
7	invalid	valid

VF motors (motors designed for use with inverters) can be used in frequency ranges lower than those for standard motors, but their cooling efficiency decreases at frequencies below 6Hz.



■ Setting of motor electronic thermal protection level 1  $\boxed{LHr}$  (Same as  $\boxed{F17}$ )

If the capacity of the motor is smaller than the capacity of the inverter, or the rated current of the motor is smaller than the rated current of the inverter, adjust the electronic thermal protection level 1  $LHr$  so that it fits the motor's rated current.

\* If the indications are in percentages (%), then 100% equals the inverter's rated output current (A).

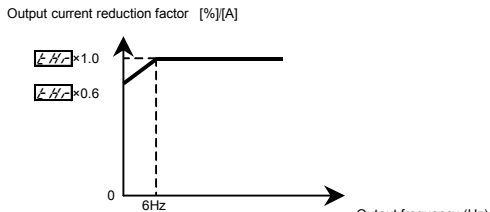

Note) The start level for motor overload reduction is fixed at 6 Hz.

2) Motor 150%-overload time  $\boxed{F607}$

Parameter  $F607$  is used to set the time elapsed before the motor trips under a load of 150% (overload trip  $\boxed{OL2}$ ) within a range of 10 to 2400 seconds.

3) Inverter overload characteristics

Set to protect the inverter itself. The setting of this parameter cannot be turned off.

When an inverter overload trip ( $\boxed{OL1}$ ) operates, operation can be improved by lowering stall operating level  $F601$ , or increasing acceleration time  $RCC$  and deceleration time  $dEL$ .

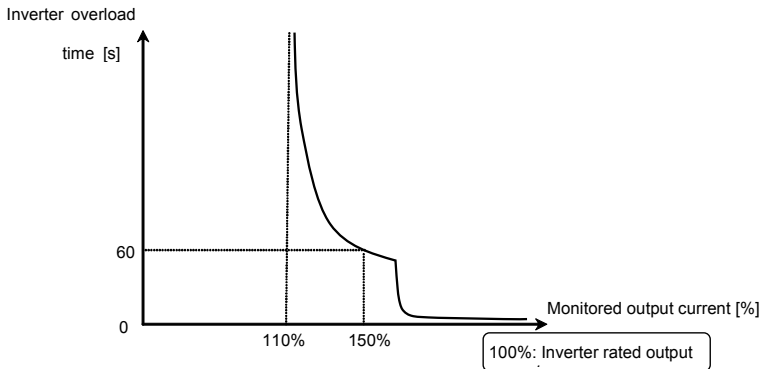

Inverter overload protection characteristic

Note 1: At extremely low speeds of lower than 1 Hz or over 150%, an overload trip ( $\overline{OL}$ ) occurs in a short period of time to protect the inverter.

Note 2: If an inverter overload occurs with the factor default settings, the inverter is set to lower the carrier frequency automatically and overload tripping is ( $\overline{OL}$ ) controlled. Although noise from the motor increases when the carrier frequency is reduced, there is no effect on performance. When reducing the carrier frequency is undesirable, set parameter  $F315 = 0$ .

#### 4) Electronic thermal memory $F632$

When the power is OFF, it is possible to reset or maintain the overload totaling level.

This parameter's settings are applied both to the motor's electronic thermal memory and the electronic thermal memory for inverter protection.

[Parameters settings]

Title	Function	Adjustment range	Default setting
$F632$	Electronic thermal memory	0: Disabled 1: Enabled	0

☆ $F632 = 1$  is a function for complying with the U.S. NEC standards.

### 3.6 Preset-speed operation (speeds in 15 steps)

$5r1$  -  $5r7$ : Preset-speed frequency 1-7

$F287$  -  $F294$ : Preset-speed frequency 8-15

- Function  
A maximum of 15 speed steps can be selected just by switching an external logic signal. Multi-speed frequencies can be programmed anywhere from the lower limit frequency  $L_L$  to the upper limit frequency  $U_L$ .

[Setting method]

1) Run/stop

The starting and stopping control is done from the terminal board.

Title	Function	Adjustment range	Setting
$FN0d$	Command mode selection	0: Terminal board 1: Panel keypad (including extension panel) 2: RS485 communication	0

Note: When switching between preset-speed operation and other speed commands (analog signal, setting dial, communication, etc.), select the frequency setting mode at  $FN0d$ . ⇒ Refer to section 3) or 5.5 in E6581595

2) Preset-speed frequency setting

Set the speed (frequency) of the number of steps necessary.

[Parameter setting]

Setting from speed 1 to speed 7

Title	Function	Adjustment range	Default setting
$5r1$ - $5r7$	Preset-speed frequency 1-7	$L_L$ - $U_L$ (Hz)	0.0

Setting from speed 8 to speed 15

Title	Function	Adjustment range	Default setting
$F287$ - $F294$	Preset-speed frequency 8-15	$L_L$ - $U_L$ (Hz)	0.0

Preset-speed logic input signal example:  $F \ 1 \ 2 \ 7$  (sink/source switching) =  $\square$ : With sink settings  
 O: ON - : OFF (Speed commands other than preset-speed commands are valid when all are OFF)

Terminal	Preset-speed														
	1	2	3	4	5	6	7	8	9	10	11	12	13	14	15
S1-CC	O	-	O	-	O	-	O	-	O	-	O	-	O	-	O
S2-CC	-	O	O	-	-	O	O	-	-	O	O	-	-	O	O
R-CC	-	-	-	O	O	O	O	-	-	-	-	O	O	O	O
VI-CC	-	-	-	-	-	-	-	O	O	O	O	O	O	O	O

★ Terminal functions are as follows.

- Terminal S1 .....Input terminal function selection 3A (S1)  
 $F \ 1 \ 3 = 1 \square$  (Preset-speed command 1: SS1)
- Terminal S2 .....Input terminal function selection 4A (S2)  
 $F \ 1 \ 4 = 1 \square$  (Preset-speed command 2: SS2)
- Terminal R .....Input terminal function selection 2A (R)  
 $F \ 1 \ 2 = 1 \square$  (Preset-speed command 3: SS3)
- Terminal VI .....
  - Analog/ logic input selection (VI)
  - $F \ 1 \ 9 = 2$  (logic input)
  - Input terminal function selection 5 (VI)
  - $F \ 1 \ 5 = 1 \square$  (preset-speed command 4: SS4)

★ In the default settings, SS3 and SS4 are not assigned. Assign SS3 and SS4 to R and VI with input terminal function selection. VI terminal must also be set for switching to logic input.

[ Example of a connection diagram ]  
 (with sink settings)

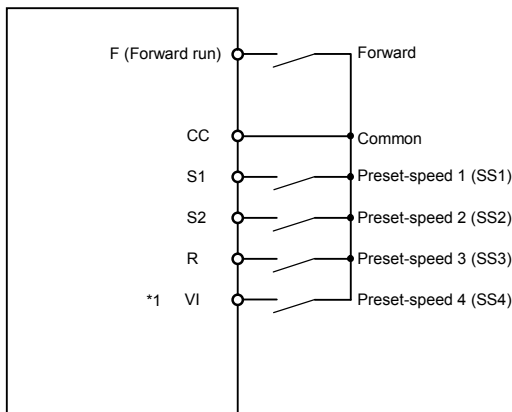

\*1: When VI terminal is used for the logic input terminal, refer to section 2.3.2 (page B-10) for details.

3) Using other speed commands with preset-speed command

Command mode selection <i>CCd</i>		0: Terminal board			1: Panel keypad (including extension panel), 2: RS485 communication		
Frequency setting mode selection <i>FFd</i>		0: Terminal board VI 5: UP/DOWN from external logic input	1: Setting dial 1 (press in center to save) 2: Setting dial 2 (save even if power is off)	3: RS485 communication	0: Terminal block VI 5: UP/DOWN from external logic input	1: Setting dial (press in center to record) 2: Setting dial	3: RS485 communication
Preset-speed command	Active	Preset-speed command valid (Note)			Terminal command valid	Setting dial command valid	Communication command valid
	Inactive	Terminal command valid	Setting dial command valid	Communication command valid	(The inverter doesn't accept Preset-speed command.)		

Note) The preset-speed command is always given priority when other speed commands are input at the same time.

An example of three-speed operation with the default settings is shown below. (Frequency settings are required for  $f_r 1$  to  $3$ )

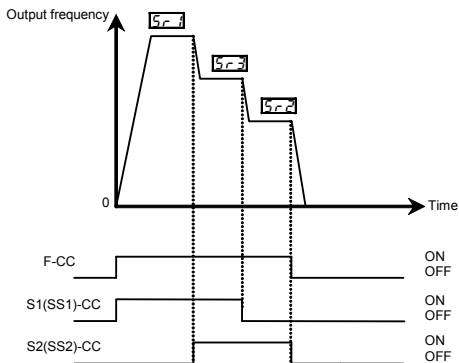

Example of 3-speed operation

## 4. Setting parameters

### 4.1 Setting and Display Modes

The VF-nC3 has the following three display modes.

Standard monitor mode

**The standard inverter mode. This mode is enabled when inverter power goes on.**

This mode is for monitoring the output frequency and setting the frequency reference value. It also displays information about status alarms during running and trips.

- Display of output frequency, etc.
  - $F \ 7 \ 1 \ 0$  Initial panel display selection
  - $(F \ 7 \ 2 \ 0)$  Initial extension panel display selection)
  - $F \ 7 \ 0 \ 2$  Free unit display scale
- Setting frequency reference values.
- Status alarm

If there is an error in the inverter, the alarm signal and the frequency will flash alternately in the LED display.

$\overline{C}$  : When a current flows at or higher than the overcurrent stall prevention level.

$P$  : When a voltage is generated at or higher than the over voltage stall prevention level.

$\overline{L}$  : When the cumulative amount of overload reaches 50% or more of the overload trip value, or when the main circuit element temperature reaches the overload alarm level

$H$  : When the overheat protection alarm level is reached

Setting monitor mode

**The mode for setting inverter parameters.**

⇒ How to set parameters, refer to section 4. 2.

There are two parameter read modes. Refer to section 4. 2 for details about selection and switching of modes.

Easy setting mode : Only the seven most frequently used parameters are displayed.

Parameters can be registered as necessary. (max. 24 parameters)

Standard setting mode : Both basic and extended all parameters are displayed.

☆ Each press of the EASY key switches between the Easy setting mode and the Standard setting mode.

Status monitor mode

**The mode for monitoring all inverter status.**

Allows monitoring of set frequencies, output current/voltage and terminal information.

⇒ Refer to chapter 8.

The inverter can be moved through each of the modes by pressing the MODE key.

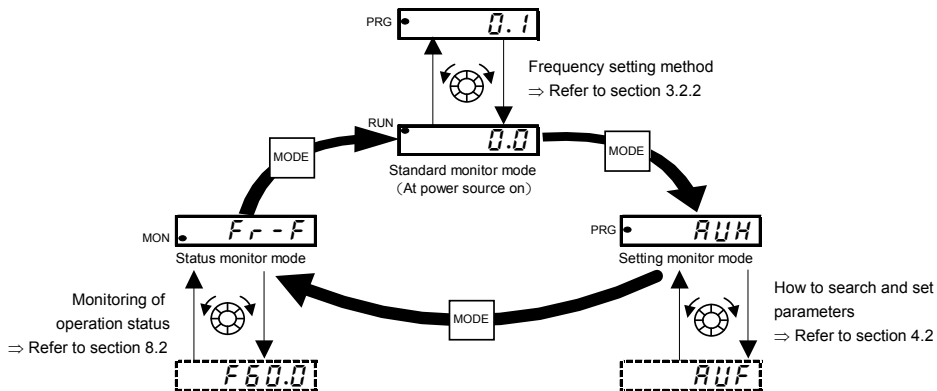

## 4.2 How to set parameters

There are two types of setting monitor modes: Easy mode and Standard setting mode. The mode active when power is turned on can be selected at *PSEL* (Registered parameter display selection), and the mode can be switched by the EASY key. Note, however, that the switching method differs when only the Easy mode is selected. Refer to section 4.5 for details.

Setting dial and panel key operations are as follows:



Turning the setting dial  
Used to select items and incrementing/  
decrementing values. (Note)



Pressing the center of the setting dial  
Used for executing operations and determining  
values. (Note)



Used to select the mode and return to  
the previous menu



Used to switch between the Easy and Standard  
setting modes.  
Each press alternately switches between the two  
modes in the standard monitor mode.

Easy setting mode

: The mode changes to the Easy setting mode when the EASY key is pressed and "EASY" is displayed. Only the most frequently used 7 basic parameters are displayed. (standard default)

Easy setting mode

Title	Function
<i>cmd</i>	Command mode selection
<i>Fnd</i>	Frequency setting mode selection
<i>RLC</i>	Acceleration time 1
<i>dEL</i>	Deceleration time 1
<i>tHr</i>	Motor overload protection level 1
<i>F<sub>0</sub></i>	Meter adjustment
<i>PSEL</i>	Registered parameter display selection

☆ In the Easy setting mode, the PRG lamp blinks.

☆ If the EASY key is pressed while the setting dial is being turned, values continue to be incremented or decremented even if you release your finger from the setting dial.

This feature is handy when setting large values.

Note) Of the available parameters, number value parameters (*RLC* etc.) are reflected in actual operation when the setting dial is turned. Note, however, that the center of the setting dial must be pressed to save values even when the power is turned off.

Note, also, that item selection parameters (*Fnd* etc.) are not reflected in actual operation by just turning the setting dial. To reflect these parameters, press the center of the setting dial.



## Standard setting mode

: The mode changes to the Standard setting mode when the EASY key is pressed and "5 5 d" is displayed.  
Both basic and extended all parameters are displayed.

## Basic parameters

: This parameter is a basic parameter for the operation of the inverter.

⇒ Refer to chapter 5 in E6581595 for details.

⇒ Refer to chapter 11 for parameter tables.

## Extended parameters

: The parameters for detailed and special setting.

⇒ Refer to chapter 6 in E6581595 for details.

⇒ Refer to chapter 11 for parameter tables.

For reasons of safety, the following parameters have been set up so that they cannot be reprogrammed while the inverter is running.

## [Basic parameters]

<i>RU1</i> (Guidance function)	<i>FH</i> (Maximum frequency)
<i>RU1</i> (Automatic acceleration/deceleration)	<i>Pt</i> (V/F control mode selection)
<i>RU2</i> (Torque boost setting macro function)	<i>54P</i> (Default setting)
<i>CR0d*</i> (Command mode selection)	<i>5Et</i> (Checking the region setting)
<i>FR0d*</i> (Frequency setting mode selection)	

## [Basic parameters]

<i>F105</i> (Priority selection (Both F and R are ON))	<i>F311</i> (Reverse-run prohibition)
<i>F108 / F110</i> (Always-active function selection 1/2)	<i>F316</i> (Carrier frequency control mode selection)
<i>F109</i> Analog/logic input selection (VI terminal)	<i>F360</i> (PID control)
<i>F111</i> to <i>F115</i> (Input terminal selection 1A to 5)	<i>F400</i> (Auto-tuning)
<i>F127</i> (Sink/source switching)	<i>F458</i> (Motor specific coefficient 2)
<i>F130</i> to <i>F137</i> (Output terminal selection 1A~1B)	<i>F480</i> to <i>F495</i> (Motor specific coefficient 7 to 9)
<i>F139</i> (Output terminal logic selection(OUT-NO))	<i>F603</i> (Emergency stop selection)
<i>F144</i> (Factory specific coefficient 1A)	<i>F605</i> (Output phase failure detection mode selection)
<i>F151</i> to <i>F156</i> (Input terminal selection 1B~2C)	<i>F608</i> (Input phase failure detection mode selection)
<i>F301</i> (Auto-restart control selection)	<i>F613</i> (Detection of output short-circuit during start-up)
<i>F302</i> (Regenerative power ride-through control (Deceleration stop))	<i>F627</i> (Undervoltage trip/alarm selection)
<i>F305</i> (Overvoltage limit operation (Slowdown stop mode selection))	<i>F631</i> (Factory specific coefficient 6A)
<i>F307</i> (Supply voltage correction (limitation of output voltage))	<i>F669</i> (Logic output/pulse train output selection (OUT-NO))
	<i>F681</i> (Analog output signal selection)

\**CR0d* and *FR0d* can be changed during operation by setting *F735=0*.

## 4.2.1 Settings in the Easy setting mode

The inverter enters this mode by pressing the MODE key when the Easy setting mode is selected

When you are unsure of something during operation:  
You can return to the Standard monitor mode by pressing the MODE key several times.

Easy setting mode (Default registered parameters)

Title	Function
<i>CNOd</i>	Command mode selection
<i>FNOd</i>	Frequency setting mode selection
<i>ACC</i>	Acceleration time 1
<i>dEC</i>	Deceleration time 1
<i>tHr</i>	Motor overload protection level 1
<i>FN</i>	Connection meter adjustment
<i>PSEL</i>	Registered parameter display selection

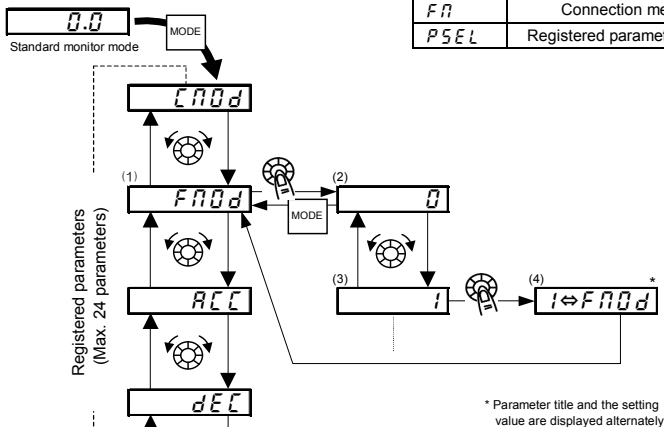

### ■ Setting parameters in the Easy setting mode

- (1) Selects parameter to be changed. (Turn the setting dial.)
- (2) Reads the programmed parameter setting. (Press the center of the setting dial.)
- (3) Change the parameter value. (Turn the setting dial.)
- (4) Press this key to save the change. (Press the center of the setting dial.)

☆ To switch to the Standard setting mode, press the EASY key in the Standard monitor mode. "5 & d" is displayed, and the mode is switched.

## 4.2.2 Settings in the Standard setting mode

The inverter enters this mode by pressing the MODE key when the Standard setting mode is selected.

When you are unsure of something during operation:  
You can return to the Standard monitor mode by pressing the MODE key several times.

### ■ How to set basic parameters

- (1) Selects parameter to be changed. (Turn the setting dial.)
- (2) Reads the programmed parameter setting. (Press the center of the setting dial.)
- (3) Change the parameter value. (Turn the setting dial.)
- (4) Press this key to save the change. (Press the center of the setting dial.)

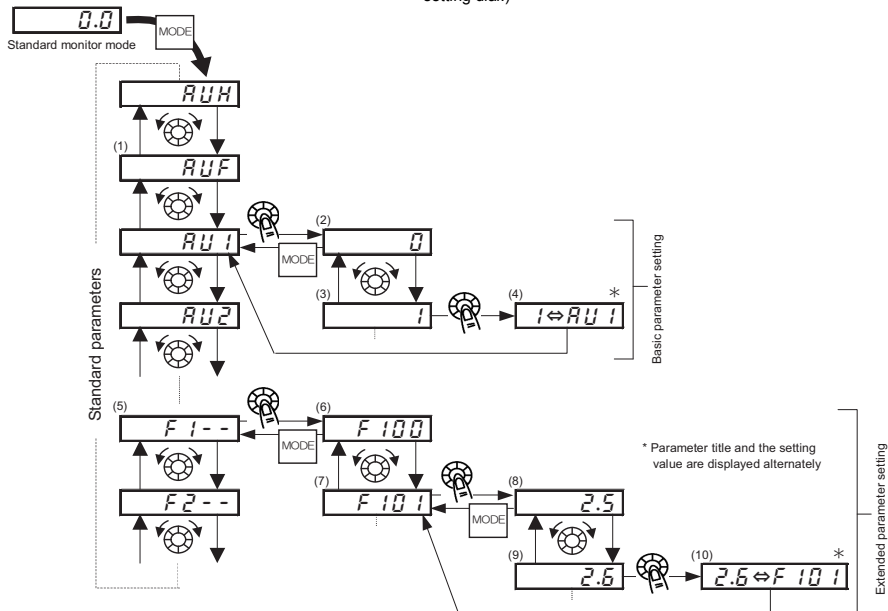

☆ To switch to the Easy setting mode, press the EASY key in the Standard monitor mode. **EASY** is displayed, and the mode is switched.

■ How to set extended parameters

Each extended parameter is composed of an "F"suffixed with a 3-digit figure, so first select and read out the heading of the parameter you want "F 1 - -" to "F 8 - -". ("F 1 - -": Parameter starting point is 100, "F 8 - -": Parameter starting point is 800.)

- (5) Select the title of the parameter you want to change. (Turn the setting dial.)
- (6) Press the Enter key to activate the selected parameter. (Press the center of the setting dial.)
- (7) Selects parameter to be changed. (Turn the setting dial.)
- (8) Reads the programmed parameter setting. (Press the center of the setting dial.)
- (9) Change the parameter value. (Turn the setting dial.)
- (10) Press this key to save the change. (Press the center of the setting dial.)

■ Adjustment range and display of parameters

**H I**: An attempt has been made to assign a value that is higher than the programmable range. (Note that the setting of the currently selected parameter may exceed the upper limit as a result of changing other parameters.)

**L Q**: An attempt has been made to assign a value that is lower than the programmable range. (Note that the setting of the currently selected parameter may fall below the lower limit as a result of changing other parameters.)

If the above alarm is flashing on and off, values that exceed **H I** or are equal or lower than **L Q** cannot be set.

4

## 4.3 Functions useful in searching for a parameter or changing a parameter setting

This section explains functions useful in searching for a parameter or changing a parameter setting. To use these functions, a parameter needs to be selected or set in advance.

Changed parameters history search (History function) **R U H**

This function automatically searches for the last five parameters whose settings have been changed. To use this function, select the **R U H** parameter. (Any changes are displayed regardless of whether or not they are the same as standard defaults.)

⇒ Refer to section 5.1 in E6581595 for details.

Set parameters by purpose (Guidance function) **R U F**

Only parameters required for a special purpose can be called up and set.

To use this function, select parameter **R U F**

⇒ Refer to section 5.2 in E6581595 for details.

Reset parameters to default settings  $\boxed{\text{EYP}}$

Use the  $\text{EYP}$  parameter to reset all parameters back to their default settings. To use this function, set parameter  $\text{EYP}=\overline{3}$  or  $\overline{13}$ .

⇒ Refer to section 4.3.2 for details.

Call saved customer settings  $\boxed{\text{EYP}}$

Customer settings can be batch-saved and batch-called.

These settings can be used as customer-exclusive default settings.

To use this function, set parameter  $\text{EYP}=\overline{7}$  or  $\overline{8}$ .

⇒ Refer to section 4.3.2 for details.

Search changed parameters  $\boxed{\text{Gru}}$

Automatically searches for only those parameters that are programmed with values different from the standard default setting. To use this function, select the  $\text{Gru}$  parameter.

⇒ Refer to section 4.3.1 for details.

## 4.3.1 Searching for and resetting changed parameters

$\boxed{\text{Gru}}$  : Automatic edit function

### • Function

Automatically searches for only those parameters that are programmed with values different from the standard default setting and displays them in the  $\text{Gru}$ . Parameter setting can also be changed within this group.









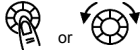

Note 1: If you reset a parameter to its factory default, the parameter will no longer appear in  $\text{Gru}$ .

Note 2: It may take several seconds to display changed parameters because all data stored in the user parameter group  $\text{Gru}$  is checked against the factory default settings. To cancel a parameter search, press the MODE key.

Note 3: Parameters which cannot be reset to the default setting after setting  $\text{EYP}$  to  $\overline{3}$  are not displayed.

⇒ Refer to section 4.3.2 for details.

■ How to search and reprogram parameters

Panel operation	LED display	Operation
	<i>0.0</i>	Displays the operation frequency (operation stopped). (When standard monitor display selection is set as <i>F 7 1 0=0</i> [operation frequency])
	<i>R U H</i>	Displays the first basic parameter "History function ( <i>R U H</i> )."
	<i>U r U</i>	Turn the setting dial, and select <i>U r U</i> .
	<i>U - - -</i>	Press the center of the setting dial to enter the user parameter setting change search mode.
	<i>R C C</i>	Searches for and displays parameters different to the default settings. Parameters are changed by either pressing the center of the setting dial or turning it to the right. (Turning the setting dial to the left searches for parameter in the reverse direction.)
	<i>8.0</i>	Press the center of the setting dial to display set values.
	<i>5.0</i>	Turn the setting dial, and change set values.
	<i>5.0 ↔ R C C</i>	Press the center of the setting dial to set values. The parameter name and set value light alternately and are written.
	<i>U - - F</i> ( <i>U - - r</i> )	Use the same steps as those above and turn the setting dial to display parameters to search for or whose settings must be changed, and check or change the parameter settings.
	<i>U r U</i>	When <i>U r U</i> appears again, the search is ended.
  	Parameter display ↓ <i>U r U</i> ↓ <i>F r - F</i> ↓ <i>0.0</i>	A search can be canceled by pressing the MODE key. Press the key once while the search is underway to return to the display of parameter setting mode. Pressing it while searching returns to the <i>U r U</i> display. After that you can press the MODE key to return to the status monitor mode or the standard monitor mode (display of operation frequency).

## 4.3.2 Return to default settings

**Ⓛ Ⓜ Ⓟ** : Default setting

- Function

It is possible to return groups of parameters to their defaults, clear run times, and record/recall set parameters.

[Parameter setting]

Title	Function	Adjustment range	Default setting
Ⓛ Ⓜ Ⓟ	Default setting	0: - 1: 50Hz default setting 2: 60Hz default setting 3: Default setting 1 (Initialization) 4: Trip record clear 5: Cumulative operation time clear 6: Initialization of type information 7: Save user setting parameters 8: Load user setting parameters 9: Cumulative fan operation time record clears 10 to 12: - 13: Default setting 2 (complete initialization)	0

★ This function will be displayed as 0 during reading on the right. This previous setting is displayed.

Example: **Ⓛ Ⓜ Ⓟ**

★ Ⓛ Ⓜ Ⓟ cannot be set during the inverter operating. Always stop the inverter first and then program.

### Programmed value

50 Hz default setting (Ⓛ Ⓜ Ⓟ = 1)

Setting Ⓛ Ⓜ Ⓟ to 1 sets the following parameters for base frequency 50 Hz use.

(The setting values of other parameters are not changed.)

- Max. frequency (FH) : 50Hz
- Base frequency 1 (ωL) : 50Hz
- VI input point 2 frequency (F2D4) : 50Hz
- Upper limit frequency (UL) : 50Hz
- Base frequency 2 (F17D) : 50Hz
- Motor rated RPM (F417) : 1410 min<sup>-1</sup>

60 Hz default setting (Ⓛ Ⓜ Ⓟ = 2)

Setting Ⓛ Ⓜ Ⓟ to 2 sets the following parameters for base frequency 60 Hz use.

(The setting values of other parameters are not changed.)

- Max. frequency (FH) : 60Hz
- Base frequency 1 (ωL) : 60Hz
- VI input point 2 frequency (F2D4) : 60Hz
- Upper limit frequency (UL) : 60Hz
- Base frequency 2 (F17D) : 60Hz
- Motor rated RPM (F417) : 1710 min<sup>-1</sup>

Default setting 1 ( $\text{tYP} = 3$ )

Setting  $\text{tYP}$  to 3 will return parameters to the standard values that were programmed at the factory.

☆ When 3 is set,  $\text{[InIk]}$  is displayed for a short time after the settings are configured, and then disappears. Then the inverter is in standard motor mode. In this case, the trip history data is cleared.

Be aware that the following parameters do not return to the standard factory settings even if  $\text{tYP} = 3$  is set for maintainability. (To initialize all parameters, set  $\text{tYP} = 13$ .)

- $F5L$  : Meter selection
- $F69$  : Logic output/pulse train output selection (OUT-NO)
- $F7$  : Meter adjustment gain
- $F88$  : Analog output signal selection
- $SE$  : Checking the region setting
- $F99$  : Inclination characteristic of analog output
- $F109$  : Analog/logic input selection (VI terminal)
- $F692$  : Analog output bias
- $F127$  : Sink/source switching
- $F693$  : Factory specific coefficient 6D
- $F470$  : VI input bias
- $F888$  : Free notes
- $F471$  : VI nput gain

Trip record clear ( $\text{tYP} = 4$ )

Setting  $\text{tYP}$  to 4 initializes the past four sets of recorded error history data.

☆ The parameter does not change.

Cumulative operation time clear ( $\text{tYP} = 5$ )

Setting  $\text{tYP}$  to 5 resets the cumulative operation time to the initial value (zero).

Initialization of type information ( $\text{tYP} = 6$ )

Setting  $\text{tYP}$  to 6 clears the trips when an  $E\text{tYP}$  format error occurs. But if the  $E\text{tYP}$  displayed, call us.

Save user setting parameters ( $\text{tYP} = 7$ )

Setting  $\text{tYP}$  to 7 saves the current settings of all parameters. (Refer to section 4.2.7)

Load user setting parameters ( $\text{tYP} = 8$ )

Setting  $\text{tYP}$  to 8 loads parameter settings to (calls up) those saved by setting  $\text{tYP}$  to 7. (Refer to section 4.2.7)

☆ By setting  $\text{tYP}$  to 7 or 8, you can use parameters as your own default parameters.

Cumulative fan operation time record clear ( $\text{tYP} = 9$ )

Setting  $\text{tYP}$  to 9 resets the cumulative operation time to the initial value (zero).

Set this parameter when replacing the cooling fan, and so on

Default setting 2 ( $\text{tYP} = 13$ )

Set  $\text{tYP}$  to 13 to return all parameters to their default settings.

When 13 is set,  $\text{[InIk]}$  is displayed for a short time after the settings are configured, and then disappears. Then setup menu  $SE$  is displayed. After reviewing the setup menu items, make a setup menu selection. In this case, all parameters are returned to their defaults, and the trip history data is cleared. (Refer to section 3.1.)



## 4.4 Checking the region settings selection

**5 E L**: Checking the region setting

- Function

The region selected on the setup menu can be checked.

Also, the setup menu can be started to change to a different region.

[Parameter setting]

Title	Function	Adjustment range	Default setting
5 E L	Checking the region setting	0: Start setup menu 1: Japan (read only) 2: North America (read only) 3: Asia (read only) 4: Europe (read only)	*

\* Default setting values vary depending on the setup menu setting. Refer to section 11.5. 1 to 4 are displayed.

- Content of region settings

The number displayed when parameter 5 E L is read indicates which of the following regions was selected on the setup menu.

1: J P (Japan) is selected on the setup menu.

2: U S A (North America) is selected on the setup menu.

3: R S I A (Asia, Oceania) is selected on the setup menu.

4: E U (Europe) is selected on the setup menu.

The setup menu is started by writing 5 E L = 0.

Refer to section 3.1 for details.

Note: 1 to 4 set to parameter 5 E L are read-only. Be aware that they cannot be written.

## 4.5 EASY key function

**PSEL** : Registered parameters display selection

**F751** - **F774** : Easy setting mode parameter 1 to 24

### • Function

It is possible to switch between standard mode and easy setting mode using the EASY key.  
Up to 24 arbitrary parameters can be registered to easy setting mode.

[Parameter setting]

Title	Function	Adjustment range	Default setting
<b>PSEL</b>	Registered parameters display selection	0: Standard setting mode at power on 1: Easy setting mode at power on 2: Easy setting mode only	0

It is possible to switch between standard mode and easy setting mode using the EASY key.  
The way parameters are read out and displayed varies according to the mode selected.

### Easy setting mode

Allows pre-registration (easy setting mode parameters) of frequently changed parameters and reading of only registered parameters (maximum of 24 types).

### Standard setting mode

Standard setting mode in which all parameters are read out.

[How to read out parameters]

To enter the setting monitor mode, switch to the setting monitor mode using the EASY key, and then press the MODE key.

Turn the setting dial to read the parameter.

The relation between the parameter and the mode selected is shown below.

**PSEL=0**

\* When the power is turned on, the inverter is in standard mode. Press the EASY key to switch to easy setting mode.

**PSEL=1**

\* When the power is turned on, the inverter is in easy setting mode. Press the EASY key to switch to standard mode.

**PSEL=2**

\* Always in easy setting mode.

[How to select parameters]

In easy setting mode, only parameters registered to parameters 1 to 24 are displayed in order of registration.

The values of the default settings are shown in the table below.

[Parameter setting]

Title	Function	Adjustment range	Default setting
F 75 1	Easy setting mode parameter 1	0-999	3 (CND)
F 75 2	Easy setting mode parameter 2	0-999	4 (FRD)
F 75 3	Easy setting mode parameter 3	0-999	9 (RCC)
F 75 4	Easy setting mode parameter 4	0-999	10 (dEL)
F 75 5	Easy setting mode parameter 5	0-999	600 (tHr)
F 75 6	Easy setting mode parameter 6	0-999	6 (FR)
F 75 7	Easy setting mode parameter 7	0-999	999 (No function)
F 75 8	Easy setting mode parameter 8		
F 75 9	Easy setting mode parameter 9		
F 76 0	Easy setting mode parameter 10		
F 76 1	Easy setting mode parameter 11		
F 76 2	Easy setting mode parameter 12		
F 76 3	Easy setting mode parameter 13		
F 76 4	Easy setting mode parameter 14		
F 76 5	Easy setting mode parameter 15		
F 76 6	Easy setting mode parameter 16		
F 76 7	Easy setting mode parameter 17		
F 76 8	Easy setting mode parameter 18		
F 76 9	Easy setting mode parameter 19		
F 77 0	Easy setting mode parameter 20		
F 77 1	Easy setting mode parameter 21		
F 77 2	Easy setting mode parameter 22		
F 77 3	Easy setting mode parameter 23		
F 77 4	Easy setting mode parameter 24	0-999	50 (PSEL)

Note: If any number other than communication numbers is specified, it is regarded as 999 (no function assigned).

## 5. Main parameters

Before you operate the inverter, the parameters that you must first program are the basic parameters.  
Refer to section 11 tables of basic parameters.

For details, refer to chapter 5 in the E6581595 (Detailed manual) instruction manual. An electronic version of the E6581595 instruction manual is on the E6581608 CD-ROM bundled with the product.

## 6. Other parameters

Extended parameters are provided for sophisticated operation, fine adjustment and other special purposes. Modify parameter settings as required. ⇒ Refer to section 11, table of extended parameters.

For details, refer to chapter 6 in the E6581595 (Detailed manual) instruction manual. An electronic version of the E6581595 instruction manual is on the E6581608 CD-ROM bundled with the product.

## 7. Operations with external signal

For details, refer to chapter 7 in the E6581595 (Detailed manual) instruction manual. An electronic version of the E6581595 instruction manual is on the E6581608 CD-ROM bundled with the product.

# 8. Monitoring the operation status

## 8.1 Flow of status monitor mode

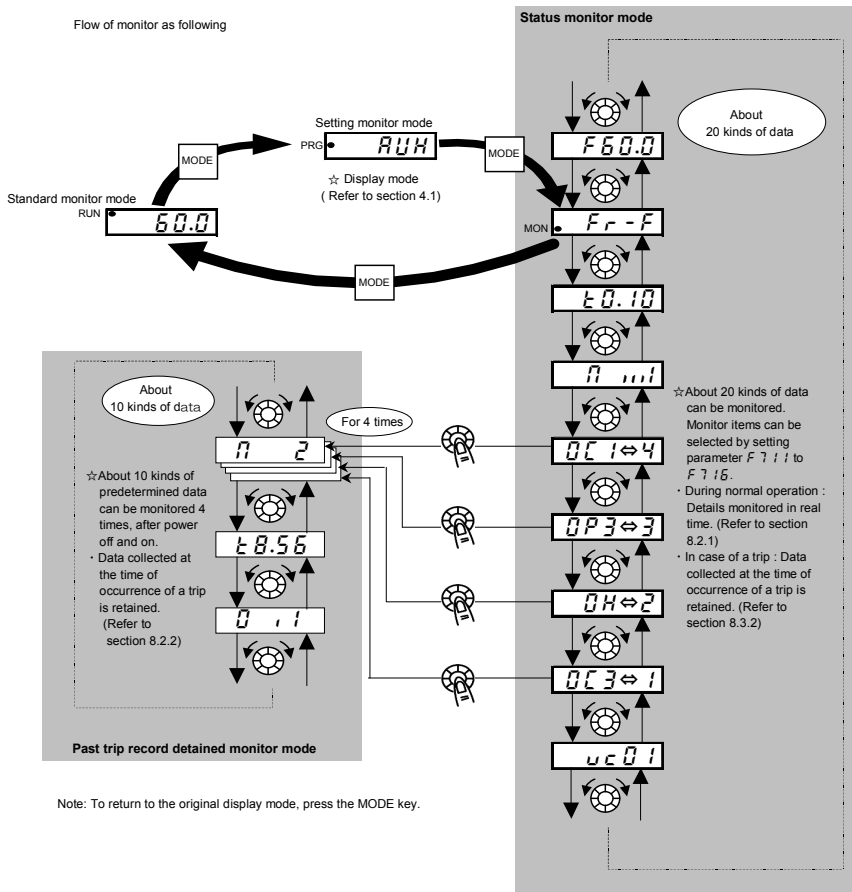

## 8.2 Status monitor mode







### 8.2.1 Status monitor under normal conditions

In this mode, you can monitor the operation status of the inverter.

To display the operation status during normal operation:

Press the MODE key twice.

Setting procedure (eg. operation at 60Hz)

Item displayed	Panel operated	LED display	Communication No.	Description
Operation frequency *		60.0		The operation frequency is displayed (Operation at 60Hz). (When standard monitor display selection $F710$ is set at 0 [operation frequency])
Parameter setting mode	MODE	RUH		The first basic parameter "RUH" (history function) is displayed.
Direction of rotation	MODE	F r - F	FE01	The direction of rotation is displayed. ( $F r - F$ : forward run, $F r - r$ : reverse run)
Note 1 Operation frequency command *		F60.0	FE02	The operation frequency command value (Hz/free unit) is displayed. ( In case of $F711=2$ )
Note 2 Output current *		□ 80	FE03	The inverter output current (load current) (%A) is displayed. ( In case of $F712=1$ )
Note 3 Input voltage *		4100	FE04	The inverter input voltage (DC detection) (%V) is displayed. ( In case of $F713=3$ )
Output voltage *		P 100	FE05	The inverter output voltage (%V) is displayed. ( In case of $F714=4$ )
Inverter load factor *		L 70	FE27	The inverter load factor (%) is displayed. ( In case of $F715=27$ )
Operation frequency *		α 60.0	FD00	The operation frequency (Hz/free unit) is displayed. ( In case of $F716=0$ )

(Continued overleaf)

\* Monitor items can be selected by setting parameters  $F710$  to  $F716$ , ( $F720$ ). Refer to Note 11.

Refer to page H-8 for notes.



(Continued)

	Item displayed	Panel operated	LED display	Communication No.	Description
Note 4	Input terminal		R . . . . .	FE06	The ON/OFF status of each of the control signal input terminals (F, R, S1, S2, V1) is displayed in bits. ON: <i>!</i> OFF: <i>,</i> 
Note 5	Output terminal		O . .	FE07	The ON/OFF status of each of the control signal output terminals (OUT and FL) is displayed in bits. ON: <i>!</i> OFF: <i>,</i> 
	Logic input terminals setting		L - 5 !	FD31	Logic setting by F 1 2 7 is displayed. L - 5 O: Source logic L - 5 !: Sink logic
	CPU1 version		v 1 0 !	FE08	The version of the CPU1 is displayed.
Note 6	CPU2 version		v c 0 !	FE73	The version of the CPU2 is displayed.
Note 6	Past trip 1		0 C 3 ⇔ !	FE10	Past trip 1 (displayed alternately)
Note 6	Past trip 2		0 H ⇔ 2	FE11	Past trip 2 (displayed alternately)
	Past trip 3		0 P 3 ⇔ 3	FE12	Past trip 3 (displayed alternately)
Note 6	Past trip 4		n E r r ⇔ 4	FE13	Past trip 4 (displayed alternately)

(Continued overleaf)

Refer to page H-8 for notes.

(Continued)

	Item displayed	Panel operated	LED display	Communication No.	Description
Note 7	Parts replacement alarm information		$n \dots i$	FE79	The ON/OFF status of each of the cooling fan, circuit board capacitor, main circuit capacitor of parts replacement alarm or cumulative operation time are displayed in bits.  ON: $i$ OFF: $\cdot$   Cumulative operation time Cooling fan Control circuit board capacitor Main circuit capacitor
Note 8	Cumulative operation time		$t 0.10$	FE14	The cumulative operation time is displayed. (0.01=1 hour, 1.00=100 hours)
	Default display mode		$60.0$		The operation frequency is displayed (Operation at 60Hz).

## 8.2.2 Display of detailed information on a past trip

Details on a past trip (of trips 1 to 4) can be displayed, as shown in the table below, by pressing the center of the setting dial when the trip record is selected in the status monitor mode.







Unlike the "Display of trip information at the occurrence of a trip" in 8.3.2, details on a past trip can be displayed, even after the inverter is turned off or reset.

	Item displayed	Panel operated	LED display	Description
Note 9	Past trip 1		$001 \leftrightarrow 1$	Past trip 1 (displayed alternately)
	Continuous trips		$n 2$	For OCA, OCL, and Err5, the number of times (maximum of 31) the same trip occurred in succession is displayed (unit: times). Detailed information is recorded at the beginning and ending numbers.
Note 1	Operation frequency		$060.0$	The operation frequency when the trip occurred is displayed.
	Direction of rotation		$F r - F$	The direction of rotation when the trip occurred is displayed. ( $F r - F$ : Forward run, $F r - r$ : Reverse run)
	Operation frequency command		$F 80.0$	The operation command value when the trip occurred is displayed.
Note 2	Output current		$115.0$	The inverter output current when the trip occurred is displayed. (%/A)
Note 3	Input voltage		$412.0$	The inverter input voltage (DC detection) when the trip occurred is displayed. (%/V).

(Continued overleaf)

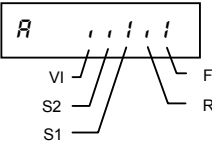
Refer to page H-8 for notes.

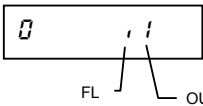
(Continued)

	Item displayed	Panel operated	LED display	Description
	Output voltage		P 100	The inverter output voltage when the trip occurred is displayed. (%V)
Note 4	Input terminal		R . . . . .	<p>The ON/OFF statuses of the control input terminals ( F, R, S1, S2, V1 ) are displayed in bits.</p> <p>ON:   OFF: ,</p> 
Note 5	Output terminal		0 . .	<p>The ON/OFF statuses of the control output terminals ( OUT and FL ) are displayed in bits.</p> <p>ON:   OFF: ,</p> 
Note 8	Cumulative operation time		t 8.56	The cumulative operation time when the trip occurred is displayed. (0.01=1 hour, 1.00=100 hours)
	Past trip 1		0C1 ↔	Press this key to return to past trip 1.

\* The monitor value of a trip is not always recorded as the maximum value because of the time required for detection.

Refer to page H-8 for notes.

## 8.3 Display of trip information

### 8.3.1 Trip code display

If the inverter trips, an error code is displayed to suggest the cause. Since trip records are retained, information on each trip can be displayed anytime in the status monitor mode.

Refer to section 13.1 for details about trip code display.







☆ The monitor value of a trip is not always recorded as the maximum value because of the time required for detection.

### 8.3.2 Display of trip information at the occurrence of a trip

At the occurrence of a trip, the same information as that displayed in the mode described in "8.2.1 Status monitor under normal conditions", can be displayed, as shown in the table below, if the inverter is not turned off or reset.

To display trip information after turning off or resetting the inverter, follow the steps described in "8.2.2 Display of detailed information on a past trip".

#### ■ Example of call-up of trip information

Item displayed	Panel operated	LED display	Communication No.	Description
Cause of trip		OP2		Status monitor mode (The code blinks if a trip occurs.) The motor coasts and comes to a stop (coast stop).
Parameter setting mode	MODE	RUH		The first basic parameter "RUH" (history function) is displayed.
Direction of rotation	MODE	F <sub>r</sub> -F	FE01	The direction of rotation at the occurrence of a trip is displayed. (F <sub>r</sub> -F: forward run, F <sub>r</sub> -r: reverser run).
Note 1 Operation frequency command *		F60.0	FE02	The operation frequency command value (Hz/free unit) at the occurrence of a trip is displayed. ( In case of F711=2 )
Note 2 Output current *		I130	FE03	The output power of the inverter at the occurrence of a trip (%A) is displayed. ( In case of F712=1 )
Note 3 Input voltage *		V141	FE04	The inverter input voltage (DC detection) (%V) at the occurrence of a trip is displayed. ( In case of F713=3 )
Output voltage *		P100	FE05	The output voltage of the inverter at the occurrence of a trip (%V) is displayed. ( In case of F714=4 )
Inverter load factor *		L70	FE27	The inverter load factor (%) at the occurrence of a trip is displayed. ( In case of F715=27 )
Note 1 Operation frequency *		o60.0	FE00	The inverter output frequency (Hz/free unit) at the occurrence of a trip is displayed. ( In case of F716=0 )

(Continued overleaf)

\* Monitor items can be selected by settings parameters F710 to F716. (F720). Note 11  
Refer to page H-8 for notes.











(Continued)

	Item displayed	Panel operated	LED display	Communication No.	Description
Note 4	Input terminal		R . . . . .	FE06	<p>The ON/OFF statuses of the control input terminals (F, R, S1, S2, V1) are displayed in bits.</p> <p>ON: <i>!</i> OFF: <i>,</i></p>
Note 5	Output terminal		0 . .	FE07	<p>The ON/OFF status of each of the control signal output terminals (OUT and FL) at the occurrence of a trip is displayed in bits.</p> <p>ON: <i>!</i> OFF: <i>,</i></p>
	Logic input terminals setting		L - 5 0	FD31	<p>Logic setting by F 1 2 7 is displayed.</p> <p>L - 5 0: Source logic L - 5 : Sink logic</p>
	CPU1 version		v 1 0 1	FE08	The version of the CPU1 is displayed.
	CPU2 version		v c 0 1	FE73	The version of the CPU2 is displayed.
Note 6	Past trip 1		0 P 2 ⇔ 1	FE10	Past trip 1 (displayed alternately)
Note 6	Past trip 2		0 H ⇔ 2	FE11	Past trip 2 (displayed alternately)
Note 6	Past trip 3		0 P 3 ⇔ 3	FE12	Past trip 3 (displayed alternately)
Note 6	Past trip 4		n E r r ⇔ 4	FE13	Past trip 4 (displayed alternately)

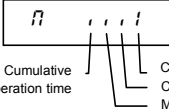
(Continued overleaf)

Refer to page H-8 for notes.

(Continued)

	Item displayed	Panel operated	LED display	Communication No.	Description
Note 7	Parts replacement alarm information			FE79	The ON/OFF status of each of the cooling fan, circuit board capacitor, main circuit capacitor of parts replacement alarm or cumulative operation time are displayed in bits. ON:  OFF:  
Note 8	Cumulative operation time			FE14	The cumulative operation time is displayed. (0.01=1 hour, 1.00=100 hours)
	Default display mode				The cause of the trip is displayed.

Note 1: The characters to the left disappear above 100 Hz. (Ex: 120 Hz is  $1\ 2\ 0.\ 0$ )

Note 2: You can switch between % and A (ampere)/V (volt), using the parameter  $F\ 7\ 0\ 1$  (current/voltage unit selection).

Note 3: The input (DC) voltage displayed is  $1/\sqrt{2}$  times as large as the rectified d.c. input voltage. In case of 1ph-120, displayed value is 1/2 times in addition.

Note 4: If  $F\ 1\ 0\ 9 = 2$  (Logic input): VI bar is activated depend on VI terminal ON/OFF.  
 If  $F\ 1\ 0\ 9 = 0, 1$  or  $3$  (Voltage/current input): VI bar is always OFF.

Note 5: If  $F\ 6\ 6\ 9 = 0$  (Logic output): Out bar is activated depend on OUT terminal ON/OFF.  
 If  $F\ 6\ 6\ 9 = 1$  (Pulse train output): OUT bar is always OFF.

Note 6: Past trip records are displayed in the following sequence: 1 (latest trip record)  $\leftrightarrow$  2  $\leftrightarrow$  3  $\leftrightarrow$  4 (oldest trip record). If no trip occurred in the past, the message "n E r r" will be displayed. Details on past trip record 1, 2, 3 or 4 can be displayed by pressing the center of the setting dial when past trip 1, 2, 3 or 4 is displayed. Refer to section 8.2.2 for details.

Note 7: Parts replacement alarm is displayed based on the value calculated from the annual average ambient temperature specified using  $F\ 6\ 3\ 4$ , the ON time of the inverter, the operating time of the motor and the output current (load factor). Use this alarm as a guide only, since it is based on a rough estimation.

Note 8: The cumulative operation time increments only when the machine is in operation.

Note 9: If there is no trip record, n E r r is displayed.

Note 10: Of the items displayed on the monitor, the reference values of items expressed in percent are listed below.

- Load current: The current monitored is displayed. The unit can be switched to A (amperes).
- Input voltage: The voltage displayed is the voltage determined by converting the voltage measured in the DC section into an AC voltage. The reference value (100% value) is 200 volts for 240V models, 100 volts for 120V models. The unit can be switched to V (volts).

- Output voltage: The voltage displayed is the output command voltage. 100% reference value is 200V on both 120V and 240V models.  
This unit can be switched to V (volts).
- Torque current: The current required to generate torque is calculated from the load current by vector operations. The value thus calculated is displayed. The reference value (100% value) is the value at the time when the load current is 100%.
- Load factor of inverter: Depending on the PWM carrier frequency ( $F300$ ) setting and so on, the actual rated current may become smaller than the rated output current indicated on the nameplate. With the actual rated current at that time (after a reduction) as 100%, the proportion of the load current to the rated current is indicated in percent. The load factor is also used to calculate the conditions for overload trip ( $0Li$ ).

Note 11: Status monitor of \* mark is displayed by  $F710$  to  $F718$  and  $F720$  setting.

The left side character is as following table by each parameter setting number.

Parameter	Setting No.	LED display	Function	Unit
$F710$ to $F716$ , $F720$	0	$a50.0$	Operation frequency	Hz / free unit
	1	$c16.5$	Output current	% / A
	2	$F50.0$	Frequency setting value	Hz / free unit
$F711$ to $F716$	3	$4100$	Input voltage (DC detection)	% / V
	4	$P90$	Output voltage (command value)	% / V
	5	$h30$	Input power	kW
	6	$H2.8$	Output power	kW
	7	$980$	Torque	%
	8	$c90$	Torque current	% / A
	9-11	-	-	-
	12	$b51.0$	Frequency setting value (after compensation)	Hz / free unit
	13-17	-	-	-
$F710$ , $F720$	18	****	Arbitrary code from communication	-
	19-22	-	-	-
	23	$d40.0$	PID feedback value	Hz / free unit
$F711$ to $F716$	24-26	-	-	-
	27	$l70$	Drive load factor	%
	28-51	-	-	-
$F710$ to $F716$ , $F720$	52	$c50.0$	During stop : Frequency setting value During operation : Operation frequency	Hz / free unit

## 9. Measures to satisfy the standards

### 9.1 How to cope with the CE directive

In Europe, the EMC directive and the low-voltage directive, which took effect in 1996 and 1997, respectively, made it obligatory to put the CE mark on every applicable product to prove that it complies with the directives. Inverters do not work alone but are designed to be installed in a control panel and always used in combination with other machines or systems which control them, so they themselves are not considered to be subject to the EMC directive. However, the CE mark must be put on all inverters because they are subject to the low-voltage directive.

The CE mark must be put on all machines and systems with built-in inverters because such machines and systems are subject to the above directives. It is the responsibility of the manufacturers of such final products to put the CE mark on each one. If they are "final" products, they might also be subject to machine-related directives. It is the responsibility of the manufacturers of such final products to put the CE mark on each one. In order to make machines and systems with built-in inverters compliant with the EMC directive and the low-voltage directive, this section explains how to install inverters and what measures should be taken to satisfy the EMC directive.

We have tested representative models with them installed as described later in this manual to check for conformity with the EMC directive. However, we cannot check all inverters for conformity because whether or not they conform to the EMC directive depends on how they are installed and connected. In other words, the application of the EMC directive varies depending on the composition of the control panel with a built-in inverter(s), the relationship with other built-in electrical components, the wiring condition, the layout condition, and so on. Therefore, please verify yourself whether your machine or system conforms to the EMC directive.

#### 9.1.1 About the EMC directive

The CE mark must be put on every final product that includes an inverter(s) and a motor(s). In the VF-nC3 series of inverters, the single-phase 200 V class is equipped with an EMI filter and complies with the EMC directive if wiring is carried out correctly.

- EMC directive  
2004/108/EC

The EMC standards are broadly divided into two categories; immunity- and emission-related standards, each of which is further categorized according to the operating environment of each individual machine. Since inverters are intended for use with industrial systems under industrial environments, they fall within the EMC categories listed in Table 1 below. The tests required for machines and systems as final products are almost the same as those required for inverters.



Table 1 EMC standards

Category	Subcategory	Product standards	Test standard
Emission	Radiation noise	IEC 61800-3	CISPR11(EN55011)
	Transmission noise		CISPR11(EN55011)
	Static discharge		IEC61000-4-2
Immunity	Radioactive radio-frequency magnetic contactor field		IEC61000-4-3
	First transient burst		IEC61000-4-4
	Lightning surge		IEC61000-4-5
	Radio-frequency induction/transmission interference		IEC61000-4-6
	Voltage dip/Interruption of power		IEC61000-4-11

## 9.1.2 Measures to satisfy the EMC directive

This subsection explains what measures must be taken to satisfy the EMC directive.

- (1) Insert a recommended EMI filter (Table 2) on the input side of the inverter to reduce and transmission noise and radiation noise from input cables.

In the combinations listed in Table 2, Inverters are tested in these combinations to see if they comply with transmission noise standards.

Table 2 lists noise filters recommended for the inverters.

Table 2 Combinations of inverter and EMI filter

Three-phase 240V class

Combination of inverter and filter		
Inverter type	Transmission noise IEC61800-3 Category C1 Applicable filters (Length of motor connecting cable: Max. 5 m, PWM carrier frequency : 4 to 12kHz)	Transmission noise IEC61800-3 Category C2 Applicable filters (Length of motor connecting cable: Max. 20 m, PWM carrier frequency : 4 to 12kHz)
VFNC3-2001P	-	EMFA2006Z
VFNC3-2002P	-	EMFA2006Z
VFNC3-2004P	-	EMFA2006Z
VFNC3-2007P	-	EMFA2006Z
VFNC3-2015P	EMFA2015Z	
VFNC3-2022P	EMFA2015Z	

## Single-phase 240 V class

Combination of inverter and filter				
Inverter type	Transmission noise IEC61800-3, category C1 applicable filters (motor wiring length of less than 5 m)	Transmission noise IEC61800-3, category C2 applicable filters (motor wiring length of less than 10 m)	Transmission noise IEC61800-3 Category C1 Applicable filters (Length of motor connecting cable: Max. 20 m, PWM carrier frequency : 4 to 12kHz)	Transmission noise IEC61800-3 Category C2 Applicable filters (Length of motor connecting cable: Max. 50 m, PWM carrier frequency : 4 to 12kHz)
VFNC3S-2001PL	Built-in filter	Built-in filter	EMFAS2011Z	
VFNC3S-2002PL			EMFAS2011Z	
VFNC3S-2004PL			EMFAS2011Z	
VFNC3S-2007PL			EMFAS2011Z	
VFNC3S-2015PL			EMFAS2025Z	
VFNC3S-2022PL			EMFAS2025Z	

## Single-phase 120 V class

Combination of inverter and filter		
Inverter type	Transmission noise IEC61800-3 Category C1 Applicable filters (Length of motor connecting cable: Max. 5 m, PWM carrier frequency : 4 to 12kHz)	Transmission noise IEC61800-3 Category C2 Applicable filters (Length of motor connecting cable: Max. 20 m, PWM carrier frequency : 4 to 12kHz)
VFNC3S-1001P	EMFAS2011Z	
VFNC3S-1002P	EMFAS2011Z	
VFNC3S-1004P	EMFAS2011Z	
VFNC3S-1007P	EMFAS2025Z	

- (2) Use shielded power cables, such as inverter output cables, and shielded control cables. Route the cables and wires so as to minimize their lengths. Keep a distance between the power cable and the control cable and between the input and output wires of the power cable. Do not route them in parallel or bind them together, instead cross at right angle.
- (3) It is more effective in limiting the radiation noise to install the inverter in a sealed steel cabinet. Using wires as thick and short as possible, earth the metal plate and the control panel securely with a distance kept between the earth cable and the power cable.
- (4) Route the input and output wires apart from each other.
- (5) To suppress radiation noise from cables, ground all shielded cables through a noise cut plate. It is effective to earth shielded cables in the vicinity of the inverter and cabinet (within a radius of 10cm from each of them). Inserting a ferrite core in a shielded cable is even more effective in limiting the radiation noise.
- (6) To further limit the radiation noise, insert a zero-phase reactor in the inverter output line and insert ferrite cores in the earth cables of the metal plate and cabinet.

[Example of wiring]

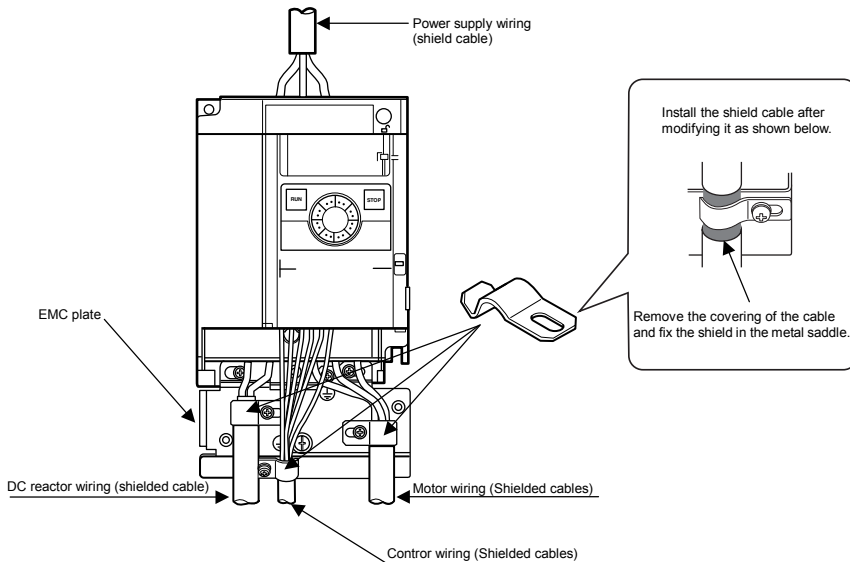

### 9.1.3 About the low-voltage directive

The low-voltage directive provides for the safety of machines and systems. All Toshiba inverters are CE-marked in accordance with the standard EN 50178 specified by the low-voltage directive, and can therefore be installed in machines or systems and imported without problem to European countries.

Applicable standard: IEC61800-5-1

Pollution level: 2

Overvoltage category: 3

## 9.1.4 Measures to satisfy the low-voltage directive

When incorporating the inverter into a machine or system, it is necessary to take the following measures so that the inverter satisfies the low-voltage directive.

- (1) Install the inverter in a cabinet and ground the inverter enclosure. When doing maintenance, be extremely careful not to put your fingers into the inverter through a wiring hole and touch a charged part, which may occur depending on the model and capacity of the inverter used.
- (2) Connect earth wiring to the earth terminal on the EMC plate. Or install the EMC plate (attached as standard) and another cable connect to earth terminal on the EMC plate. Refer to the table in 10.1 for details about earth cable sizes.
- (3) Install a non-fuse circuit breaker or a fuse on the input side of the inverter. (Refer to section 10.1 and 9.2.3)

## 9.2 Compliance with UL Standard and CSA Standard

The VF-nC3 models, that conform to the UL Standard and CSA Standard have the UL/CSA mark on the nameplate.

### 9.2.1 Compliance with Installation

A UL certificate was granted on the assumption that the inverter would be installed in a cabinet. Therefore, install the inverter in a cabinet and if necessary, take measures to maintain the ambient temperature (temperature in the cabinet) within the specified temperature range. (Refer to section 1.4.4)

### 9.2.2 Compliance with Connection

Use the UL conformed cables (Rating 75 °C or more, Use the copper conductors only.) to the main circuit terminals (3-phase models: R/L1, S/L2, T/L3, single-phase models: R/L1, S/L2/N).

For instruction in the United States, Integral solid state short circuit protection does not provide branch circuit protection. Branch circuit protection must be provided in accordance with the National Electrical Code and any additional local codes.

For instruction in the Canada, Integral solid state short circuit protection does not provide branch circuit protection. Branch circuit protection must be provided in accordance with the Canadian Electrical Code and any additional local codes.

### 9.2.3 Compliance with Peripheral devices

Use the UL listed fuses at connecting to power supply.

Short circuit test is performed under the condition of the power supply short-circuit currents in below.

These interrupting capacities and fuse rating currents depend on the applicable motor capacities.

## ■ AIC, Fuse and Wire sizes

Inverter model	Maximum voltage (V)	Input withstand rating (kA) (1)	Output interrupt rating (kA) (2)	Branch circuit protection	Rating (A)	Wire sizes of power circuit	Earth Cable
	<Y>		<X>	<Z1>	<Z2>		
VFNC3-2001P	240	5	5	Class CC	3	AWG 14	AWG 14
VFNC3-2002P	240	5	5	Class CC	5	AWG 14	AWG 14
VFNC3-2004P	240	5	5	Class CC	7	AWG 14	AWG 14
VFNC3-2007P	240	5	5	Class J	15	AWG 14	AWG 14
VFNC3-2015P	240	5	5	Class J	25	AWG 14	AWG 14
VFNC3-2022P	240	5	5	Class J	25	AWG 12	AWG 14
VFNC3-2037P	240	5	5	Class J	45	AWG 10	AWG 10
VFNC3S-2001PL	240	1	5	Class CC	5	AWG 14	AWG 14
VFNC3S-2002PL	240	1	5	Class CC	7	AWG 14	AWG 14
VFNC3S-2004PL	240	1	5	Class J	15	AWG 14	AWG 14
VFNC3S-2007PL	240	1	5	Class J	25	AWG 14	AWG 14
VFNC3S-2015PL	240	1	5	Class J	40	AWG 10	AWG 12
VFNC3S-2022PL	240	1	5	Class J	45	AWG 10	AWG 10
VFNC3S-1001P	120	1	5	Class CC	8	AWG 14	AWG 14
VFNC3S-1002P	120	1	5	Class J	15	AWG 14	AWG 14
VFNC3S-1004P	120	1	5	Class J	25	AWG 14	AWG 14
VFNC3S-1007P	120	1	5	Class J	40	AWG 10	AWG 12

Suitable for use on a circuit capable of delivering not more than   X   rms symmetrical kilo Amperes,   Y   Volts maximum, when protected by   Z1   with a maximum rating of   Z2  .

(1) Input withstand rating is that for which the product has been designed thermally. Installation on a supply greater than this level will require additional inductance to satisfy this level.





(2) Output interrupt rating relies on Integral solid state short circuit protection. This does not provide branch circuit protection. Branch circuit protection must be provided in accordance with the National Electrical Code and any additional local codes. This is dependant on the type of installation.

## 9.2.4 Motor thermal protection

Selects the electronic thermal protection characteristics that fit with the ratings and characteristics of the motor. (Refer to section 3.5)

In case of multi motor operation with one inverter, thermal relay should be connected to each motor.

## 10. Peripheral devices

 Warning	
 Prohibited	<ul style="list-style-type: none"> <li>When supplying power from a wall socket, do not exceed the rated capacity of the socket. Otherwise, this may generate excessive heat which can start a fire.</li> </ul>
 Mandatory action	<ul style="list-style-type: none"> <li>When using switchgear for the inverter, it must be installed in a cabinet. Failure to do so can lead to risk of electric shock and can result in death or serious injury.</li> </ul>
 Be Grounded	<ul style="list-style-type: none"> <li>Connect grounding cables securely. Failure to do so can lead to risk of electric shock or fire in case of a failure or short-circuit or electric leak.</li> </ul>

### 10.1 Selection of wiring materials and devices

Voltage class	Capacity of applicable motor (kW)	Inverter model	Wire size (See Note 4)					
			Power circuit (mm <sup>2</sup> ) (Note 1.)		DC reactor (optional) (mm <sup>2</sup> )		Grounding cable (mm <sup>2</sup> )	
			IEC compliant	For Japan (JEAC800 1-2005)	IEC compliant	For Japan (JEAC800 1-2005)	IEC compliant	For Japan (JEAC800 1-2005)
Three-phase 240V class	0.1	VFNC3-2001P	1.5(1.5)	2.0(2.0)	1.5	2.0	2.5	2.0
	0.2	VFNC3-2002P	1.5(1.5)	2.0(2.0)	1.5	2.0	2.5	2.0
	0.4	VFNC3-2004P	1.5(1.5)	2.0(2.0)	1.5	2.0	2.5	2.0
	0.75	VFNC3-2007P	1.5(1.5)	2.0(2.0)	1.5	2.0	2.5	2.0
	1.5	VFNC3-2015P	1.5(1.5)	2.0(2.0)	1.5	2.0	2.5	2.0
	2.2	VFNC3-2022P	2.5(1.5)	2.0(2.0)	1.5	2.0	2.5	2.0
Single-phase 240V class	0.1	VFNC3S-2001PL	1.5(1.5)	2.0(2.0)	1.5	2.0	2.5	2.0
	0.2	VFNC3S-2002PL	1.5(1.5)	2.0(2.0)	1.5	2.0	2.5	2.0
	0.4	VFNC3S-2004PL	1.5(1.5)	2.0(2.0)	1.5	2.0	2.5	2.0
	0.75	VFNC3S-2007PL	1.5(1.5)	2.0(2.0)	1.5	2.0	2.5	2.0
	1.5	VFNC3S-2015PL	2.5(2.5)	2.0(2.0)	1.5	2.0	2.5	2.0
	2.2	VFNC3S-2022PL	4.0(4.0)	2.0(2.0)	1.5	2.0	4.0	3.5
Single-phase 120V class	0.1	VFNC3S-1001P	1.5	2.0	-	-	2.5	2.0
	0.2	VFNC3S-1002P	1.5	2.0	-	-	2.5	2.0
	0.4	VFNC3S-1004P	2.5	2.0	-	-	2.5	2.0
	0.75	VFNC3S-1007P	4.0	2.0	-	-	4.0	3.5

Note 1: Sizes of the wires connected to the input terminals R/L1, S/L2 and T/L3 and the output terminals U/T1, V/T2 and W/T3 when the length of each wire does not exceed 30m.

The numeric values in parentheses refer to the sizes of wires to be used when a DC reactor is connected.

Note 2: For the control circuit, use shielded wires 0.75 mm<sup>2</sup> or more in diameter.

Note 3: For grounding, use a cable with a size equal to or larger than the above.

Note 4: The wire sizes specified in the above table apply to HIV wires (copper wires shielded with an insulator with a maximum allowable temperature of 75°C) used at an ambient temperature of 50°C or less.

Note 5: If there is a need to bring the inverter into UL compliance, use wires specified in chapter 9.

■ Selection of wiring devices

Voltage class	Applicable motor (kW) <sup>r</sup>	Input current (A)		Molded-case circuit breaker (MCCB) Earth leakage circuit breaker (ELCB)				Magnetic contactor (MC)			
		No reactor	With DCL	No reactor		with DCL		No reactor		with DCL	
				Rated current (A)	MCCB type (ELCB type)	Rated current (A)	MCCB type (ELCB type)	Rated current (A)	Model	Rated current (A)	Model
Three-phase 240V class	0.1	1.2	0.6	5	NJ30E (NJV30E)	5	NJ30E (NJV30E)	20	CA13	20	CA13
	0.2	2.0	0.9	5		5		20		20	
	0.4	3.6	1.8	5		5		20		20	
	0.75	6.3	3.5	10		5		20		20	
	1.5	11.1	6.6	15		10		20		20	
	2.2	14.9	9.3	20		15		20		20	
	4.0	23.8	16.1	30		30		32	CA20	20	
Single-phase 240V class	0.1	2.0	1.2	5	NJ30E (NJV30E)	5	NJ30E (NJV30E)	20	CA13	20	CA13
	0.2	3.4	2.1	5		5		20		20	
	0.4	5.9	4.1	10		5		20		20	
	0.75	10.2	7.7	15		10		20		20	
	1.5	17.8	14.8	30		20		20		20	
	2.2	24	20.3	30		30		32	CA20	32	CA20
Single-phase 120V class	0.1	3.5	-	5	NJ30E (NJV30E)	-	-	20	CA13	-	-
	0.2	6.0	-	10		-		20		-	
	0.4	11.4	-	15		-		20		-	
	0.75	18.9	-	30		-		20		-	

Note 1: Models made by Toshiba Industrial Products Sales Corporation are shown.

Note 2: Be sure to attach a surge killer to the exciting coil of the relay and the magnetic contactor.

Note 3: When using the auxiliary contacts 2a of the magnetic contactor MC for the control circuit, connect the contacts 2a in parallel to increase reliability.

Note 4: When a motor is driven by commercial power supply using commercial power supply / inverter switching circuit, use a magnetic contactor appropriated AC-3 class the motor rated current.

Note 5: Select an MCCB with a current breaking rating appropriate to the capacity of the power supply, because short-circuit currents vary greatly depending on the capacity of the power supply and the condition of the wiring system. The MCCB, MC and ELCB in this table were selected, on the assumption that a power supply with a normal capacity would be used.

10

## 10.2 Installation of a magnetic contactor

If using the inverter without installing a magnetic contactor (MC) in the primary circuit, use an MCCB (with a power cutoff device) to open the primary circuit when the inverter protective circuit is activated.

When using an optional brake module, install a magnetic contactor (MC) or non-fuse circuit breaker with a power cutoff device on the primary power supply of the inverter, so that the power circuit opens when the failure detection relay (FL) in the inverter or the externally installed overload relay is actuated.

### ■ Magnetic contactor in the primary circuit

To detach the inverter from the power supply in any of the following cases, insert a magnetic contactor (primary-side magnetic contactor) between the inverter and the power supply.

- (1) If the motor overload relay is tripped
- (2) If the protective detector (FL) built into the inverter is activated
- (3) In the event of a power failure (for prevention of auto-restart)
- (4) If the resistor protective relay is tripped when a braking resistor and braking module (option) are used

When using the inverter with no magnetic contactor (MC) on the primary side, install a non-fuse circuit breaker with a voltage tripping coil instead of an MC and adjust the circuit breaker so that it will be tripped if the protective relay referred to above is activated. To detect a power failure, use an undervoltage relay or the like.

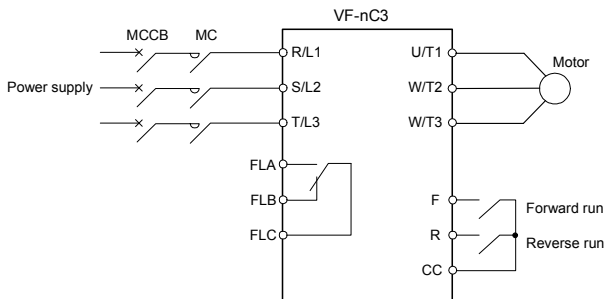

Example of connection of a magnetic contactor in the primary circuit

### Notes on wiring

- When frequently switching between start and stop, do not use the magnetic contactor on the primary side as an on-off switch for the inverter.  
Instead, stop and start the inverter by using terminals F and CC (forward run) or R and CC (reverse run).
- Be sure to attach a surge killer to the exciting coil of the magnetic contactor (MC).



## ■ Magnetic contactor in the secondary circuit

A magnetic contactor may be installed on the secondary side to switch controlled motors or supply commercial power to the load when the inverter is out of operation.

### Notes on wiring

- Be sure to interlock the magnetic contactor on the secondary side with the power supply to prevent commercial power from being applied to the inverter output terminals.
- When installing a magnetic contactor (MC) between the inverter and the motor, avoid turning the magnetic contactor on or off during operation. Turning the magnetic contactor on or off during operation causes a current to rush into the inverter which could lead to malfunction.

## 10.3 Installation of an overload relay

---

- 1) The VF-nC3 inverter has an electronic-thermal overload protective function.  
In the following cases, however, an overload relay suitable for the adjustment of the motor electronic thermal protection level ( $I_{th}$ ) and appropriate to the motor used should be installed between the inverter and the motor.
  - When using a motor with a current rating different to that of the corresponding Toshiba general-purpose motor
  - When operating a single motor with an output smaller than that of the applicable standard motor or more than one motor simultaneously.
- 2) When using the VF-nC3 inverter to operate a constant-torque motor, such as the Toshiba VF motor, adjust the protection characteristic of the electronic thermal protection unit ( $I_{th}$ ) to the VF motor use.
- 3) It is recommended to use a motor with a thermal relay embedded in the motor coil to give sufficient protection to the motor, especially when it runs in a low-speed range.

## 10.4 Optional external devices

The following external devices are optionally available for this inverter.

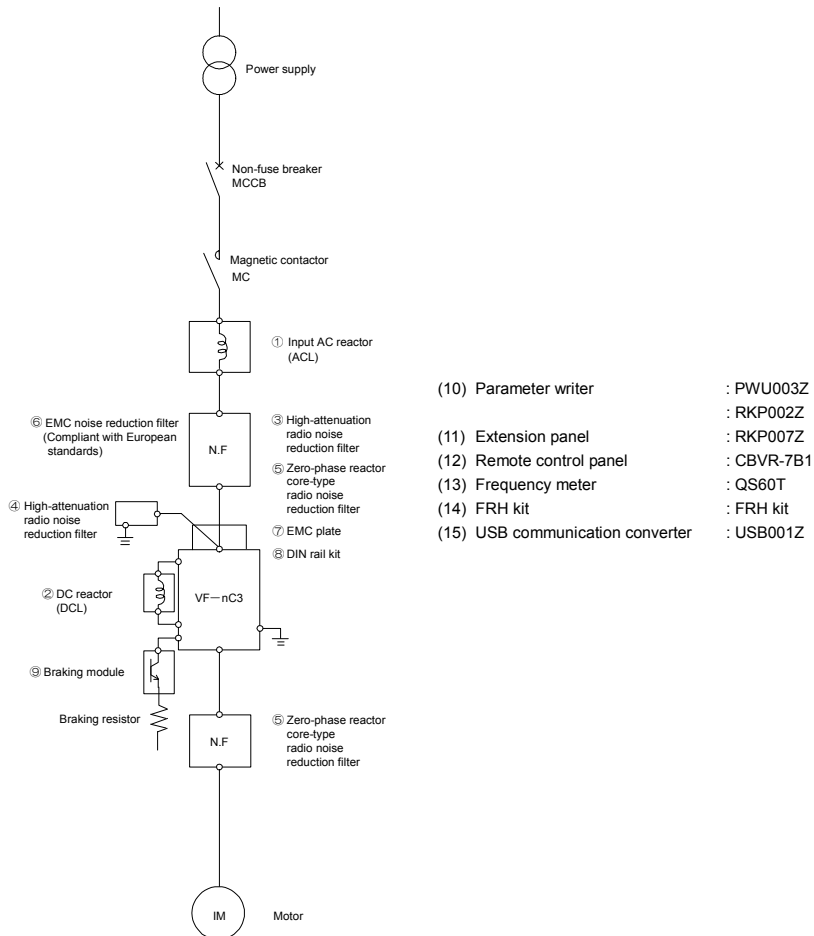

# 11. Table of parameters and data

## 11.1 User parameters

Title	Function	Unit	Minimum setting unit Panel/Communication	Adjustment range	Default setting	User setting	Reference
<i>F</i> $\square$	Operation frequency of operation panel	Hz	0.1/0.01	$\square\square - \square\square\square$	0.0		3.2.2

## 11.2 Basic parameters

### • Four navigation functions

Title	Communication No.	Function	Unit	Minimum setting unit Panel/Communication	Adjustment range	Default setting	User setting	Reference
<i>R</i> $\square$ $\square$	-	History function	-	-	Displays parameters in groups of five in the reverse order to that in which their settings were changed. * (Possible to edit)	-		4.3 5.1
<i>R</i> $\square$ $\square$	0093	Guidance function	-	-	0: - 1: - 2: Preset speed guidance 3: Analog signal operation guidance 4: Motor 1 & 2 switching operation guidance 5: Motor constant setting guidance	0		4.3 5.2
<i>R</i> $\square$ $\square$	0000	Automatic acceleration/deceleration	-	-	0: Disabled (manual setting) 1: Automatic 2: Automatic (only at acceleration)	0		5.3
<i>R</i> $\square$ $\square$	0001	Torque boost setting macro function	-	-	0: Disabled 1: Automatic torque boost + auto-tuning 2: Vector control + auto-tuning 3: Energy saving + auto-tuning	0		5.4

### • Basic parameters

Title	Communication No.	Function	Unit	Minimum setting unit Panel/Communication	Adjustment range	Default setting	User setting	Reference
<i>C</i> $\square$ $\square$ $\square$	0003	Command mode selection	-	-	0: Terminal board 1: Panel keypad (including extension panel) 2: RS485 communication	1		3 5.5 7.3
<i>F</i> $\square$ $\square$ $\square$	0004	Frequency setting mode selection	-	-	0: Terminal board VI 1: Setting dial 1 (press in center to save) 2: Setting dial 2 (save even if power is off) 3: RS485 communication 4: - 5: UP/DOWN from external logic input	2		3 5.5 6.5.1 7.3

Title	Communication No.	Function	Unit	Minimum setting unit Panel/Communication	Adjustment range	Default setting	User setting	Reference
<i>F<math>\bar{N}</math>SL</i>	0005	Meter selection	-	-	0: Output frequency 1: Output current 2: Frequency reference 3: Input voltage (DC detection) 4: Output voltage (command value) 5 to 11: - 12: Frequency setting value (after compensation) 13: V1 input value 14: - 15: Fixed output 1 (output current 100% equivalent) 16: Fixed output 2 (output current 50% equivalent) 17: Fixed output 3 (Other than the output current) 18: RS485 communication data 19: For adjustments ( <i>F<math>\bar{N}</math></i> set value is displayed.) 20 to 22: -	0		3.4
<i>F<math>\bar{N}</math></i>	0006	Meter adjustment gain	-	-	-	-		
<i>F<math>\bar{r}</math></i>	0008	Forward/reverse run selection (Panel keypad)	-	-	0: Forward run 1: Reverse run 2: Forward run (F/R switching on extension panel) 3: Reverse run (F/R switching on extension panel)	0		5.7
<i>R<math>\bar{E}</math><math>\bar{L}</math></i>	0009	Acceleration time 1	S	0.1/0.1	0.0-3000	10.0		5.3
<i>d<math>\bar{E}</math><math>\bar{L}</math></i>	0010	Deceleration time 1	S	0.1/0.1	0.0-3000	10.0		
<i>F<math>\bar{H}</math></i>	0011	Maximum frequency	Hz	0.1/0.01	30.0-400.0	*1		5.8
<i>U<math>\bar{L}</math></i>	0012	Upper limit frequency	Hz	0.1/0.01	0.5- <i>F<math>\bar{H}</math></i>	*1		5.9
<i>l<math>\bar{L}</math></i>	0013	Lower limit frequency	Hz	0.1/0.01	0.0- <i>U<math>\bar{L}</math></i>	0.0		
<i>u<math>\bar{L}</math></i>	0014	Base frequency 1	Hz	0.1/0.01	20.0-400.0	*1		5.10
<i>u<math>\bar{L}</math>u</i>	0409	Base frequency voltage 1	V	1/0.1	50-330	*1		5.10 6.12.5
<i>P<math>\bar{L}</math></i>	0015	V/F control mode selection	-	-	0: V/F constant 1: Variable torque 2: Automatic torque boost control 3: Vector control 4: Energy-saving	0		5.11
<i>u<math>\bar{b}</math></i>	0016	Torque boost value 1	%	0.1/0.1	0.0-30.0	*2		5.12
<i>t<math>\bar{H}</math>r</i>	0600	Motor electronic-thermal protection level 1	% (A)	1/1	10-100	100		3.5 6.16.1

\*1: Default setting values vary depending on the setup menu setting. Refer to section 11.5.

\*2: Default setting values vary depending on the capacity. Refer to section 11.4.

Title	Communication No.	Function	Unit	Minimum setting unit Panel/Communication	Adjustment range	Default setting	User setting	Reference		
0L7	0017	Electronic-thermal protection characteristic selection	-	-	Setting	Overload protection	OL stall	0	3.5	
					0	valid	invalid			
					1	Standard motor	valid			valid
					2	invalid	invalid			
					3	invalid	valid			
					4	valid	invalid			
					5	VF motor	valid			valid
					6	invalid	invalid			
7	invalid	valid								
5r1	0018	Preset-speed frequency 1	Hz	0.1/0.01	L L -UL	0.0		3.6		
5r2	0019	Preset-speed frequency 2	Hz	0.1/0.01	L L -UL	0.0				
5r3	0020	Preset-speed frequency 3	Hz	0.1/0.01	L L -UL	0.0				
5r4	0021	Preset-speed frequency 4	Hz	0.1/0.01	L L -UL	0.0				
5r5	0022	Preset-speed frequency 5	Hz	0.1/0.01	L L -UL	0.0				
5r6	0023	Preset-speed frequency 6	Hz	0.1/0.01	L L -UL	0.0				
5r7	0024	Preset-speed frequency 7	Hz	0.1/0.01	L L -UL	0.0				
t4P	0007	Default setting	-	-	0: - 1: 50Hz default setting 2: 60Hz default setting 3: Default setting 1 (Initialization) 4: Trip record clear 5: Cumulative operation time clear 6: Initialization of type information 7: Save user setting parameters 8: Load user setting parameters 9: Cumulative fan operation time record clears 10 to 12: - 13: Default setting 2 (Complete initialization)	0		4.3 4.3.2		
5E t	0099	Checking the region setting	-	-	0: Start setup menu 1: Japan (read only) 2: North America (read only) 3: Asia (read only) 4: Europe (read only)	* 1 * 5		4.4		
PSE L	0050	Registered parameters display selection	-	-	0: Standard setting mode at power on 1: Easy setting mode at power on 2: Easy setting mode only	0		4.5		
F1 -	-	Extended parameter starting at 100	-	-	-	-	-	4.2.2		
F2 -	-	Extended parameter starting at 200	-	-	-	-	-			
F3 -	-	Extended parameter starting at 300	-	-	-	-	-			
F4 -	-	Extended parameter starting at 400	-	-	-	-	-			
F5 -	-	Extended parameter starting at 500	-	-	-	-	-			
F6 -	-	Extended parameter starting at 600	-	-	-	-	-			
F7 -	-	Extended parameter starting at 700	-	-	-	-	-			
F8 -	-	Extended parameter starting at 800	-	-	-	-	-			
Gr U	-	Automatic edit function	-	-	-	-	-		4.3.1	

\*1: Default setting values vary depending on the setup menu setting. Refer to section 11.5.

\*5: The region is set to 1 to 4 when parameter 5E t is read. To re-select a region, set "0" to start up the setup menu.

## 11.3 Extended parameters

### • Input/output parameters 1

Title	Communication No.	Function	Unit	Minimum setting unit Panel/Communication	Adjustment range	Default setting	User setting	Reference
F 100	0100	Low-speed signal output frequency	Hz	0.1/0.01	0.0- <i>FH</i>	0.0		6.1.1
F 101	0101	Speed reach setting frequency	Hz	0.1/0.01	0.0- <i>FH</i>	0.0		6.1.3
F 102	0102	Speed reach detection band	Hz	0.1/0.01	0.0- <i>FH</i>	2.5		6.1.2 6.1.3
F 105	0105	Priority selection (Both F and R are ON)	-	-	0: Reverse 1: Slowdown Stop	1		6.2.1
F 108	0108	Always active function selection 1	-	-	0-123	0 (No function)		6.3.2
F 109	0109	Analog/logic input Selection (VI terminal)	-	-	0: Voltage signal input (0-10V) 1: Current signal input (4-20mA) 2: Logic input 3: Voltage signal input (0-5V)	0		6.2.2 6.3.3 6.5.2 7.2.1 7.3
F 110	0110	Always active function selection 2	-	-	0-123	6 (ST)		6.3.2
F 111	0111	Input terminal selection 1A (F)	-	-	0-201	2 (F)		6.3.3 6.5.1
F 112	0112	Input terminal selection 2A (R)	-	-	0-201	4 (R)		7.2.1
F 113	0113	Input terminal selection 3A (S1)	-	-	0-201	10 (SS1)		
F 114	0114	Input terminal selection 4A (S2)	-	-	0-201	12 (SS2)		
F 115	0115	Input terminal selection 5 (VI)	-	-	8-55	14 (SS3)		
F 127	0127	Sink/source switching	-	-	0: Sink (Internal power supply), 100: Source, 200: Sink (External power supply) 1-99, 101-199, 201-255: invalid	*1		6.3.1
F 130	0130	Output terminal selection 1A (OUT)	-	-	0-255	4 (LOW)		6.3.4 7.2.2
F 132	0132	Output terminal selection 2 (FL)	-	-	0-255	10 (FL)		
F 137	0137	Output terminal selection 1B (OUT)	-	-	0-255	255 (always ON)		
F 139	0139	Output terminal logic selection (OUT)	-	-	0: <i>F 130</i> and <i>F 137</i> 1: <i>F 130</i> or <i>F 137</i>	0		6.3.4 7.2.2
F 144	0144	Factory specific coefficient 1A	-	-	-	-		*3

\*1: Default setting values vary depending on the setup menu setting. Refer to section 11.5.

\*3: Factory specific coefficient parameters are manufacturer setting parameters. Do not change the value of these parameters.

Title	Communication No.	Function	Unit	Minimum setting unit Panel/Communication	Adjustment range	Default setting	User setting	Reference
F 15 1	0151	Input terminal selection 1B (F)	-	-	0-201	0		6.3.3 6.5.1 7.2.1
F 15 2	0152	Input terminal selection 2B (R)	-	-	0-201	0		
F 15 3	0153	Input terminal selection 3B (S1)	-	-	0-201	0		
F 15 4	0154	Input terminal selection 4B (S2)	-	-	0-201	0		
F 15 5	0155	Input terminal selection 1C (F)	-	-	0-201	0		
F 15 6	0156	Input terminal selection 2C (R)	-	-	0-201	0		

### • Basic parameter 2

Title	Communication No.	Function	Unit	Minimum setting unit Panel/Communication	Adjustment range	Default setting	User setting	Reference
F 17 0	0170	Base frequency 2	Hz	0.1/0.01	20.0-400.0	* 1		6.4.1
F 17 1	0171	Base frequency voltage 2	V	1/0.1	50-330	* 1		
F 17 2	0172	Torque boost value 2	%	0.1/0.1	0.0-30.0	* 2		
F 17 3	0173	Motor electronic-thermal protection level 2	% (A)	1/1	10-100	100		3.5 6.4.1 6.16.1
F 18 5	0185	Stall prevention level 2	% (A)	1/1	10-199, 200 (disabled)	150		6.4.1 6.19.2

### • Frequency parameters

Title	Communication No.	Function	Unit	Minimum setting unit Panel/Communication	Adjustment range	Default setting	User setting	Reference
F 2 0 1	0201	V1 input point 1 setting	%	1/1	0-100	0		6.5.2 7.3
F 2 0 2	0202	V1 input point 1 frequency	Hz	0.1/0.01	0.0-400.0	0.0		
F 2 0 3	0203	V1 input point 2 setting	%	1/1	0-100	100		
F 2 0 4	0204	V1 input point 2 frequency	Hz	0.1/0.01	0.0-400.0	* 1		
F 2 0 9	0209	Analog input filter	ms	1/1	4-1000	64		
F 2 4 0	0240	Starting frequency setting	Hz	0.1/0.01	0.1-10.0	0.5		6.6.1
F 2 4 1	0241	Operation starting frequency	Hz	0.1/0.01	0.0-F H	0.0		6.6.2
F 2 4 2	0242	Operation starting frequency hysteresis	Hz	0.1/0.01	0.0-F H	0.0		
F 2 4 9	0249	Factory specific coefficient 2A	-	-	-	-		

\*1: Default setting values vary depending on the setup menu setting. Refer to section 11.5.

\*2: Default setting values vary depending on the capacity. Refer to section 11.4.

\*3: Factory specific coefficient parameters are manufacturer setting parameters. Do not change the value of these parameters.

Title	Communication No.	Function	Unit	Minimum setting unit Panel/Communication	Adjustment range	Default setting	User setting	Reference
F250	0250	DC braking starting frequency	Hz	0.1/0.01	0.0-FH	0.0		6.7
F251	0251	DC braking current	%(A)	1/1	0-100	50		
F252	0252	DC braking time	s	0.1/0.1	0.0-25.5	1.0		
F256	0256	Time limit for lower-limit frequency operation	s	0.1/0.1	0: Disabled 0.1-600.0	0.0		6.8
F264	0264	External logic input - UP response time	s	0.1/0.1	0.0-10.0	0.1		6.5.3
F265	0265	External logic input - UP frequency steps	Hz	0.1/0.01	0.0-FH	0.1		
F266	0266	External logic input - DOWN response time	s	0.1/0.1	0.0-10.0	0.1		
F267	0267	External logic input - DOWN frequency steps	Hz	0.1/0.01	0.0-FH	0.1		
F268	0268	Initial value of UP/DOWN frequency	Hz	0.1/0.01	L-L-U-L	0.0		
F269	0269	Change of the initial value of UP/DOWN frequency	-	-	0: Not changed 1: Setting of F268 changed when power is turned off	1		
F270	0270	Jump frequency	Hz	0.1/0.01	0.0-FH	0.0		
F271	0271	Jumping width	Hz	0.1/0.01	0.0-30.0	0.0		
F287	0287	Preset-speed frequency 8	Hz	0.1/0.01	L-L-U-L	0.0		
F288	0288	Preset-speed frequency 9	Hz	0.1/0.01	L-L-U-L	0.0		
F289	0289	Preset-speed frequency 10	Hz	0.1/0.01	L-L-U-L	0.0		
F290	0290	Preset-speed frequency 11	Hz	0.1/0.01	L-L-U-L	0.0		
F291	0291	Preset-speed frequency 12	Hz	0.1/0.01	L-L-U-L	0.0		
F292	0292	Preset-speed frequency 13	Hz	0.1/0.01	L-L-U-L	0.0		
F293	0293	Preset-speed frequency 14	Hz	0.1/0.01	L-L-U-L	0.0		
F294	0294	Preset-speed frequency 15	Hz	0.1/0.01	L-L-U-L	0.0		



• Operation mode parameters

Title	Communication No.	Function	Unit	Minimum setting unit Panel/Communication	Adjustment range	Default setting	User setting	Reference
F300	0300	PWM carrier frequency	kHz	1/0.1	2-16	12		6.11
F301	0301	Auto-restart control selection	-	-	0: Disabled 1: At auto-restart after momentary stop 2: At ST terminal off and on 3: 1+2 4: At start-up	0		6.12.1
F302	0302	Regenerative power ride-through control (Deceleration stop)	-	-	0: Disabled 1: Automatic setting 2: Slowdown stop	0		6.12.2
F303	0303	Retry selection (number of times)	Times	1/1	0: Disabled 1-10	0		6.12.3
F305	0305	Oversvoltage limit operation (Slowdown stop mode selection)	-	-	0: Enabled 1: Disabled 2: Enabled (Quick deceleration control) 3: Enabled (Dynamic quick deceleration control)	2		6.12.4
F307	0307	Supply voltage correction (output voltage limitation)	-	-	0: Supply voltage uncorrected, output voltage limited 1: Supply voltage corrected, output voltage limited 2: Supply voltage uncorrected, output voltage unlimited 3: Supply voltage corrected, output voltage unlimited	* 1		6.12.5
F311	0311	Reverse-run prohibition	-	-	0: Forward/reverse run permitted 1: Reverse run prohibited 2: Forward run prohibited	0		6.12.6
F312	0312	Random mode	-	-	0: Disabled 1: Automatic setting	0		6.11
F316	0316	Carrier frequency control mode selection	-	-	0: Carrier frequency without reduction 1: Carrier frequency with automatic reduction	1		
F359	0359	PID control waiting time	s	1/1	0-2400	0		6.13
F360	0360	PID control	-	-	0: Disabled, 1: Enabled	0		
F362	0362	Proportional gain	-	0.01/0.01	0.01-100.0	0.30		
F363	0363	Integral gain	-	0.01/0.01	0.01-100.0	0.20		
F366	0366	Differential gain	-	0.01/0.01	0.00-2.55	0.00		
F380	0380	PID forward/reverse characteristics selection	-	-	0: Forward 1: Reverse	0		
F391	0391	Hysteresis for lower-limit frequency operation	Hz	0.1/0.01	0.0-UL	0.2		6.8.1

\* 1: Default setting values vary depending on the setup menu setting. Refer to section 11.5.

• Torque boost parameters 1

Title	Communication No.	Function	Unit	Minimum setting unit Panel/Communication	Adjustment range	Default setting	User setting	Reference
F400	0400	Auto-tuning	-	-	0: Auto-tuning disabled 1: Initialization of F402 (reset to 0) 2: Auto-tuning executed (after execution: 0)	0		6.14
F401	0401	Slip frequency gain	%	1/1	0-150	50		
F402	0402	Automatic torque boost value	%	0.1/0.1	0.1-30.0	* 2		
F405	0405	Motor rated capacity	kW	0.01/0.01	0.01-5.50	* 2		
F412	0412	Motor specific coefficient 1	-	-	-	-		* 4
F415	0415	Motor rated current	A	0.1/0.1	0.1-30.0	* 2		6.14
F416	0416	Motor no-load current	%	1/1	10-90	* 2		
F417	0417	Motor rated speed	min-1	1/1	100-32000	* 1		
F458	0458	Motor specific coefficient 2	-	-	-	-		* 4
F459	0459	Load inertia moment ratio	Times	0.1/0.1	0.1-100.0	1.0		6.14
F460	0460	Motor specific coefficient 3	-	-	-	-		* 4
F461	0461	Motor specific coefficient 4	-	-	-	-		
F462	0462	Motor specific coefficient 5	-	-	-	-		
F467	0467	Motor specific coefficient 6	-	-	-	-		

• Input/output parameters 2

Title	Communication No.	Function	Unit	Minimum setting unit Panel/Communication	Adjustment range	Default setting	User setting	Reference
F470	0470	VI input bias	-	1/1	0-255	128		6.5.4
F471	0471	VI input gain	-	1/1	0-255	128		

• Torque boost parameters 2

Title	Communications No.	Function	Unit	Minimum setting unit Panel/Communications	Adjustment range	Default setting	User setting	Reference
F480	0480	Motor specific coefficient 7	-	-	-	-		* 4
F485	0485	Motor specific coefficient 8	-	-	-	-		
F495	0495	Motor specific coefficient 9	-	-	-	-		

\*1: Default setting values vary depending on the setup menu setting. Refer to section 11.5.

\*2: Default setting values vary depending on the capacity. Refer to section 11.4.

\*4: Motor specific coefficient parameters are manufacturer setting parameters. Do not change the value of these parameters.

• Acceleration/deceleration time parameters

Title	Communication No.	Function	Unit	Minimum setting unit Panel/Communication	Adjustment range	Default setting	User setting	Reference
F500	0500	Acceleration time 2	s	0.1/0.1	0.0-3000	10.0		6.15
F501	0501	Deceleration time 2	s	0.1/0.1	0.0-3000	10.0		
F502	0502	Acceleration/deceleration 1 pattern	-	-	0: Linear 1: S-pattern 1	0		
F503	0503	Acceleration/deceleration 2 pattern	-	-	2: S-pattern 2	0		
F505	0505	Acceleration/deceleration 1 & 2 switching frequency	Hz	0.1/0.01	0.0 (disabled) 0.1-11	0.0		

• Protection parameters

Title	Communication No.	Function	Unit	Minimum setting unit Panel/Communication	Adjustment range	Default setting	User setting	Reference
F601	0601	Stall prevention level 1	% (A)	1/1	10-199, 200 (disabled)	150		6.16.2
F602	0602	Inverter trip retention selection	-	-	0: Cleared with power off 1: Retained with power off	0		6.16.3
F603	0603	Emergency stop selection	-	-	0: Coast stop 1: Slowdown stop 2: Emergency DC braking	0		6.16.4
F605	0605	Output phase failure detection selection	-	-	0: Disabled 1: At start-up (only one time after power on) 2: At start-up (each time)	0		6.16.5
F607	0607	Motor 150% overload detection time	s	1/1	10-2400	300		3.5 6.16.1
F608	0608	Input phase failure detection selection	-	-	0: Disabled, 1: Enabled	1		6.16.6

Title	Communication No.	Function	Unit	Minimum setting unit Panel/Communication	Adjustment range	Default setting	User setting	Reference
F609	0609	Small current detection hysteresis	%	1/1	1-20	10		6.16.7
F610	0610	Small current trip/alarm selection	-	-	0: Alarm only 1: Tripping	0		
F611	0611	Small current detection current	% (A)	1/1	0-150	0		
F612	0612	Small current detection time	s	1/1	0-255	0		
F613	0613	Detection of output short-circuit at start-up	-	-	0: Each time (standard pulse) 1: Only one time after power on (standard pulse) 2: Each time (short pulse) 3: Only one time after power on (short pulse)	0		6.16.8
F615	0615	Over-torque trip/alarm selection	-	-	0: Alarm only 1: Tripping	0		6.16.9
F616	0616	Over-torque detection level	%	1/1	0 (disabled) 1-200	150		
F618	0618	Over-torque detection time	s	0.1/0.1	0.0-10.0	0.5		
F619	0619	Over-torque detection hysteresis	%	1/1	0-100	10		
F620	0620	Cooling fan ON/OFF control	-	-	0: ON/OFF control 1: Always ON	0		6.16.10
F621	0621	Cumulative operation time alarm setting	100 hours	0.1/0.1 (=10 hours)	0.0-999.0	610.0		6.16.11
F627	0627	Undervoltage trip/alarm selection	-	-	0: Alarm only (detection level 64% or less) 1: Tripping (detection level 64% or less) 2: Alarm only (detection level 50% or less, input AC reactor required)	0		6.16.12
F631	0631	Factory specific coefficient 6A	-	-	-	-		* 3
F632	0632	Electronic-thermal memory	-	-	0: Disabled 1: Enabled	0		3.5 6.16.1
F633	0633	VI analog input break detection level	%	1/1	0: Disabled, 1-100	0		6.16.13
F634	0634	Annual average ambient temperature (parts replacement alarms)	-	-	1: -10 to +10°C 2: 11-20°C 3: 21-30°C 4: 31-40°C 5: 41-50°C 6: 51-60°C	3		6.16.14

\*3: Factory specific coefficient parameters are manufacturer setting parameters. Do not change the value of these parameters.

• Output parameters

Title	Communication No.	Function	Unit	Minimum setting unit Panel/Communication	Adjustment range	Default setting	User setting	Reference
F 6 6 9	0669	Logic output/pulse train output selection (OUT)	-	-	0: Logic output 1: Pulse train output	0		6.17.1
F 6 7 6	0676	Pulse train output function selection (OUT)	-	-	0: Output frequency 1: Output current 2: Frequency reference 3: Input voltage (DC detection) 4: Output voltage (command value) 5 to 11: 12: Frequency setting value (after compensation) 13: VI input value 14: - 15: Fixed output 1 (output current 100% equivalent) 16: Fixed output 2 (output current 50% equivalent) 17: Fixed output 3 (Other than the output current) 18: RS485 Communication data 19 to 22: -	0		6.17.1
F 6 7 7	0677	Maximum numbers of pulse train	kpps	0.01/0.01	0.50-1.60	0.80		
F 6 7 8	0678	Factory specific coefficient 6B	-	-	-	-		* 3
F 6 8 1	0681	Analog output signal selection	-	-	0: Meter option (0 to 1 mA) 1: Current (0 to 20 mA) output 2: Voltage (0 to 10 V) output	0		6.17.2
F 6 8 4	0684	Factory specific coefficient 6C	-	-	-	-		* 3
F 6 9 1	0691	Inclination characteristic of analog output	-	-	0: Negative inclination (downward slope) 1: Positive inclination (upward slope)	1		6.17.2
F 6 9 2	0692	Analog output bias	%	0.1/0.1	-1.0--+100.0	0		
F 6 9 3	0693	Factory specific coefficient 6D	-	-	-	-		* 3

• Operation panel parameters

Title	Communication No.	Function	Unit	Minimum setting unit Panel/Communication	Adjustment range	Default setting	User setting	Reference
F 7 0 0	0700	Parameter write protection selection	-	-	0: Permitted 1: Prohibited (Panel and extension panel) 2: Prohibited (1 + RS485 communication)	0		6.18.1
F 7 0 1	0701	Current/voltage unit selection	-	-	0: % 1: A (ampere)/V (volt)	0		6.18.2
F 7 0 2	0702	Free unit display scale	Times	0.01/0.01	0.00: Disabled (display of frequency) 0.01-200.0	0.00		6.18.3
F 7 0 7	0707	Free step (1-step rotation of setting dial)	Hz	0.01/0.01	0.00: Disabled 0.01-FH	0.00		6.18.4

\*3: Factory specific coefficient parameters are manufacturer setting parameters. Do not change the value of these parameters.

Title	Communication No.	Function	Unit	Minimum setting unit Panel/Communication	Adjustment range	Default setting	User setting	Reference
F 7 1 0	0710	Initial panel display selection	-	-	0: Operation frequency (Hz/free unit) 1: Output current (%A) 2: Frequency setting value (Hz/free unit) 3 to 17: - 18: Arbitrary code from communication 19 to 51: - 52: Frequency setting value / Operation frequency (Hz/free unit)	0		6.18.5 8.2.1 8.3.2
F 7 1 1	0711	Status monitor 1	-	-	0: Operation frequency (Hz/free unit) 1: Output current (%A)	2		8.2.1 8.3.2
F 7 1 2	0712	Status monitor 2	-	-	2: Frequency setting value (Hz/free unit) 3: Input voltage (DC detection) (%V) 4: Output voltage (command value) (%V)	1		
F 7 1 3	0713	Status monitor 3	-	-	5: Input power (kW) 6: Output power (kW)	3		
F 7 1 4	0714	Status monitor 4	-	-	7: Torque (%) 8: Torque current (%A)	4		
F 7 1 5	0715	Status monitor 5	-	-	9 to 11: - 12: Frequency setting value (after compensation) (Hz/free unit)	27		
F 7 1 6	0716	Status monitor 6	-	-	13 to 22: - 23: PID feedback value (Hz/free unit) 24 to 26: - 27: Drive load factor (%) 28 to 51: - 52: Frequency setting value / Operation frequency (Hz/free unit)	0		
F 7 2 0	0720	Initial extension panel display selection	-	-	0-52 (Same as F 7 1 0)	0		6.18.5 8.2.1 8.3.2
F 7 3 0	0730	Panel frequency setting prohibition (F 7)	-	-	0: Permitted 1: Prohibited	0		6.18.1
F 7 3 2	0732	Local/remote key prohibition of extension panel	-	-	0: Permitted 1: Prohibited	1		
F 7 3 3	0733	Panel operation prohibition (RUN/STOP keys)	-	-	0: Permitted 1: Prohibited	0		
F 7 3 4	0734	Panel emergency stop operation prohibition	-	-	0: Permitted 1: Prohibited	0		
F 7 3 5	0735	Panel reset operation prohibition	-	-	0: Permitted 1: Prohibited	0		
F 7 3 6	0736	Change prohibition during operation	-	-	0: Permitted 1: Prohibited	1		
F 7 3 8	0738	Password setting (F 7 0 0)	-	-	0: Password unset 1-9998 9999: Password set	0		
F 7 3 9	0739	Password verification	-	-	0: Password unset 1-9998 9999: Password set	0		

Title	Communication No.	Function	Unit	Minimum setting unit Panel/Communication	Adjustment range	Default setting	User setting	Reference
F 746	0746	Factory specific coefficient 7A	-	-	-	-		* 3
F 751	0751	Easy setting mode parameter 1	-	-	0-999 (Set by communication number)	3		4.5
F 752	0752	Easy setting mode parameter 2	-	-		4		
F 753	0753	Easy setting mode parameter 3	-	-		9		
F 754	0754	Easy setting mode parameter 4	-	-		10		
F 755	0755	Easy setting mode parameter 5	-	-		600		
F 756	0756	Easy setting mode parameter 6	-	-		6		
F 757	0757	Easy setting mode parameter 7	-	-		999		
F 758	0758	Easy setting mode parameter 8	-	-		999		
F 759	0759	Easy setting mode parameter 9	-	-		999		
F 760	0760	Easy setting mode parameter 10	-	-		999		
F 761	0761	Easy setting mode parameter 11	-	-		999		
F 762	0762	Easy setting mode parameter 12	-	-		999		
F 763	0763	Easy setting mode parameter 13	-	-		999		
F 764	0764	Easy setting mode parameter 14	-	-		999		
F 765	0765	Easy setting mode parameter 15	-	-		999		
F 766	0766	Easy setting mode parameter 16	-	-		999		
F 767	0767	Easy setting mode parameter 17	-	-		999		
F 768	0768	Easy setting mode parameter 18	-	-		999		
F 769	0769	Easy setting mode parameter 19	-	-		999		
F 770	0770	Easy setting mode parameter 20	-	-		999		
F 771	0771	Easy setting mode parameter 21	-	-		999		
F 772	0772	Easy setting mode parameter 22	-	-		999		
F 773	0773	Easy setting mode parameter 23	-	-		999		
F 774	0774	Easy setting mode parameter 24	-	-		50		
F 799	0799	Factory specific coefficient 7B	-	-	-	-		* 3

\*3: Factory specific coefficient parameters are manufacturer setting parameters. Do not change the value of these parameters.

• Communication parameters

Title	Communication No.	Function	Unit	Minimum setting unit Panel/Communication	Adjustment range	Default setting	User setting	Reference	
F800	0800	Baud rate	-	-	3: 9600bps 4: 19200bps 5: 38400bps	4		6.19	
F801	0801	Parity	-	-	0: NON (No parity) 1: EVEN (Even parity) 2: ODD (Odd parity)	1			
F802	0802	Inverter number	-	1/1	0-247	0			
F803	0803	Communication time-out time	s	0.1/0.1	0.0: Disabled, 0.1-100.0	0.0			
F804	0804	Communication time-out action	-	-	0: Alarm only 1: Trip (Coast stop) 2: Trip (Deceleration stop)	0			
F808	0808	Communication time-out detection condition	-	-	0: Valid at any time 1: Communication selection of <i>F80d</i> or <i>L80d</i> 2: 1 + during operation	1			
F829	0829	Selection of communication protocol	-	-	0: Toshiba inverter protocol 1: Modbus RTU protocol	0			
F870	0870	Block write data 1	-	-	0: No selection 1: Command information 2: -	0			
F871	0871	Block write data 2	-	-	3: Frequency setting 4: Output data on the terminal board 5: Analog output for communication	0			
F875	0875	Block read data 1	-	-	0: No selection 1: Status information	0			
F876	0876	Block read data 2	-	-	2: Output frequency 3: Output current	0			
F877	0877	Block read data 3	-	-	4: Output voltage 5: Alarm information	0			
F878	0878	Block read data 4	-	-	6: PID feedback value 7: Input terminal board monitor	0			
F879	0879	Block read data 5	-	-	8: Output terminal board monitor 9: VI terminal board monitor	0			
F880	0880	Free notes	-	1/1	0-65535	0			6.20

Note: Chapter 5, 6 or 7 indicated in the reference column refers to item "E6581595" in the instruction manual.



## 11.4 Default settings by inverter rating

Inverter type	Torque boost value	Automatic torque boost value	Motor rated capacity	Motor rated current	Motor no-load current
	$\omega b / F 172$ (%)	$F 402$ (%)	$F 405$ (kW)	$F 415$ (A)	$F 416$ (%)
VFNC3-2001P	6.0	10.3	0.10	0.6	75
VFNC3-2002P	6.0	8.3	0.20	1.2	70
VFNC3-2004P	6.0	6.2	0.40	2.0	65
VFNC3-2007P	6.0	5.8	0.75	3.4	60
VFNC3-2015P	6.0	4.3	1.50	6.2	55
VFNC3-2022P	5.0	4.1	2.20	8.9	52
VFNC3-2037P	5.0	3.4	4.00	14.8	48
VFNC3S-2001PL	6.0	10.3	0.10	0.6	75
VFNC3S-2002PL	6.0	8.3	0.20	1.2	70
VFNC3S-2004PL	6.0	6.2	0.40	2.0	65
VFNC3S-2007PL	6.0	5.8	0.75	3.4	60
VFNC3S-2015PL	6.0	4.3	1.50	6.2	55
VFNC3S-2022PL	5.0	4.1	2.20	8.9	52
VFNC3S-1001P	6.0	10.3	0.10	0.6	75
VFNC3S-1002P	6.0	8.3	0.20	1.2	70
VFNC3S-1004P	6.0	6.2	0.40	2.0	65
VFNC3S-1007P	6.0	5.8	0.75	3.4	60

## 11.5 Default settings by setup menu

Setting	Main regions	Max. frequency	Frequency	Base frequency voltage 1 & 2	Sink/source switching	Supply voltage correction (output voltage limitation)	Motor rated speed
		$F H$ (Hz)	$\omega L \omega L$ , $F 170$ , $F 204$ (Hz)	$\omega L \omega F 171$ (V)	$F 127$	$F 307$	$F 417$ (min <sup>-1</sup> )
$J P$	Japan	80.0	60.0	200	0 (Sink)	3	1710
$U S A$	North America	60.0	60.0	230	0 (Sink)	2	1710
$R S I A$	Asia	50.0	50.0	230	0 (Sink)	2	1410
$E U$	Europe	50.0	50.0	230	100 (Source)	2	1410

## 11.6 Input Terminal Function

### • Table of input terminal functions 1

Function No.	Code	Function	Action	Reference
0,1	-	No function	Disabled	-
2	F	Forward run command	ON: Forward run, OFF: Slowdown stop	3.2,1
3	FN	Inversion of forward run command	Inversion of F	7.2,1
4	R	Reverse run command	ON: Reverse run, OFF: Slowdown stop	3.2,1
5	RN	Inversion of reverse run command	Inversion of R	7.2,1
6	ST	Standby	ON: Ready for operation OFF: Coast stop (gate OFF)	3.2,1
7	STN	Inversion of standby	Inversion of ST	
8	RES	Reset command	ON: Acceptance of reset command ON → OFF: Trip reset	13.2
9	RESN	Inversion of reset command	Inversion of RES	
10	SS1	Preset-speed command 1	Selection of 15-speed SS1 to SS4 (SS1N to SS4N) (4 bits)	3.6
11	SS1N	Inversion of preset-speed command 1		7.2,1
12	SS2	Preset-speed command 2		
13	SS2N	Inversion of preset-speed command 2		
14	SS3	Preset-speed command 3		
15	SS3N	Inversion of preset-speed command 3		
16	SS4	Preset-speed command 4		3.6
17	SS4N	Inversion of preset-speed command 4		
18	JOG	Jog run mode	ON: Jogging mode (fixed at 5Hz) OFF: Jog run canceled	7.2,1
19	JOGN	Inversion of jog run mode	Inversion of JOG	
20	EXT	Emergency stop by external signal	ON: $\bar{E}$ trip stop OFF: After stopped by $F603$ , $\bar{E}$ trip	6.16.4
21	EXTN	Inversion of emergency stop by external signal	Inversion of EXT	
22	DB	DC braking command	ON: DC braking, OFF: Brake canceled	6.7,1
23	DBN	Inversion of DC braking command	Inversion of DB	
24	AD2	2nd acceleration/deceleration	ON: Acceleration/deceleration 2 OFF: Acceleration/deceleration 1	6.4,1
25	AD2N	Inversion of 2nd acceleration/deceleration	Inversion of AD2	6.15,1
28	VF2	2nd V/F control mode switching	ON: 2nd V/F control mode (V/F fixed, $F170$ , $F171$ , $F172$ , $F173$ ) OFF: 1st V/F control mode ( $Pk$ setting, $uL$ , $uL$ , $u$ , $u$ , $u$ , $u$ , $b$ , $t$ , $Hr$ )	6.4,1
29	VF2N	Inversion of 2nd V/F control switching	Inversion of VF2	
32	OCS2	2nd stall prevention level	ON: Enabled at the value of $F185$ OFF: Enabled at the value of $F601$	6.4,1
33	OCS2N	Inversion of 2nd stall prevention level	Inversion of OCS2	6.16,2
36	PID	PID control prohibition	ON: PID control prohibited OFF: PID control enabled	6.13
37	PIDN	Inversion of PID control prohibition	Inversion of PID	
48	SCLC	Forced local from communication	Enabled during communication ON: Local (Setting of $L0d$ , $F0d$ ) OFF: Communication	5.5 6.19
49	SCLCN	Inversion of forced local from communication	Inversion of SCLC	
50	HD	Operation hold (hold of 3-wire operation)	ON: F (forward run), R: (reverse run) held, 3-wire operation OFF: Slowdown stop	7.2,1
51	HDN	Inversion of operation hold (hold of 3-wire operation)	Inversion of HD	
52	IDC	PID integral/differential clear	ON: Integral/differential clear, OFF: Clear canceled	6.13
53	IDCN	Inversion of PID integral/differential clear	Inversion of IDC	
54	DR	PID characteristics switching	ON: Inverted characteristics of $F380$ selection OFF: Characteristics of $F380$ selection	
55	DRN	Inversion of PID characteristics switching	Inversion of DR	

• Table of input terminal functions 2

Function No.	Code	Function	Action	Reference
88	UP	Frequency UP	ON: Frequency increased OFF: Frequency increase canceled	6.5.3
89	UPN	Inversion of frequency UP	Inversion of UP	
90	DWN	Frequency DOWN	ON: Frequency decreased OFF: Frequency decrease canceled	
91	DWNN	Inversion of frequency DOWN	Inversion of DWN	
92	CLR	Clear frequency UP/DOWN	OFF → ON: Clear frequency UP/DOWN	
93	CLRN	Inversion of clear frequency UP/DOWN	Inversion of CLR	
96	FRR	Coast stop command	ON: Coast stop (Gate OFF) OFF: Coast stop canceled	3.2.1
97	FRRN	Inversion of coast stop command	Inversion of FRP	
106	FMTB	Frequency setting mode terminal board VI	ON: Terminal board (VI) enabled OFF: Setting of $F \cancel{R} \cancel{D} \cancel{d}$	5.5
107	FMTBN	Inversion of frequency setting mode terminal board VI	Inversion of FMTB	
108	CMTB	Command mode terminal board	ON: Terminal board enabled OFF: Setting of $\cancel{C} \cancel{R} \cancel{D} \cancel{d}$	
109	CMTBN	Inversion of command mode terminal board	Inversion of CMTB	
110	PWE	Parameter editing permission	ON: Parameter editing permitted OFF: Setting of $F \cancel{R} \cancel{D} \cancel{d}$	6.18.1
111	PWEN	Inversion of parameter editing permission	Inversion of PWE	
122	FST	Forced deceleration command	ON: Forced deceleration command (Automatic deceleration) OFF: Forced deceleration canceled (Note that operation is resumed when forced deceleration is canceled)	5.3.1
123	FSTN	Inversion of forced deceleration command	Inversion of FST	
200	PWP	Parameter editing prohibition	ON: Parameter editing prohibited OFF: Setting of $F \cancel{R} \cancel{D} \cancel{d}$	6.18.1
201	PWPN	Inversion of parameter editing prohibition	Inversion of PWP	

Note 1: Function No. 26, 27, 30, 31, 34, 35, 38 to 47, 50, 51, 56 to 87, 94, 95, 98 to 105, 112 to 121 and 124 to 199 are assigned "No function".

Note 2: Function No. are different from those on the VF-nC1. Pay attention to substitute function No. from VF-nC1 to VF-nC3. The combination function in VF-nC1 (e.g. F+SS1) can be realized by plural assignable functions ( $F \cancel{1} \cancel{5} \cancel{1}$  to  $F \cancel{1} \cancel{5} \cancel{6}$ ). As a combination is not constraint, various operation is possible. Refer to section 7.2.1 in E6581594 for details.

• Input terminal function priority

Code	Function No.	2,3 4,5	6,7	8,9	10,11 12,13 14,15 16,17	18 19	20 21	22 23	24,25 28,29 32,33	36,37 52,53 54,55	48 49 106 107 108 109	50 51	88,89 90,91 92,93	96 97	110 111 200 201	122 123
F/ R	2,3 4,5		X	○	○	○	X	X	○	○	○	○	○	X	○	X
ST	6,7	⊙	○	○	⊙	⊙	○	⊙	○	○	○	⊙	○	○	○	⊙
RES	8,9	○	○	○	○	○	X	○	○	○	○	○	○	○	○	○
SS1/ SS2/ SS3/ SS4	10,11 12,13 14,15 16,17	○	X	○		X	X	X	○	○	○	○	○	X	○	X
JOG	18,19	○	X	○	⊙		X	X	○	⊙	○	X	○	X	○	X
EXT	20,21	⊙	○	⊙	⊙	⊙		⊙	○	○	○	⊙	○	○	○	⊙
DB	22,23	⊙	X	○	⊙	⊙	X		○	⊙	○	⊙	○	X	○	X
AD2/ VF2/ OCS2	24,25 28,29 32,33	○	○	○	○	○	○	○		○	○	○	○	○	○	○
PID/ IDC/ PIDSW	36,37 52,53 54,55	○	○	○	○	X	○	X	○		○	○	○	○	○	○
SCLC/ FMTB/ CMTB	48,49 106,107 108,109	○	○	○	○	○	○	○	○	○		○	○	○	○	○
HD	50,51	○	X	○	○	X	X	X	○	○	○		○	X	○	X
UP/ DWN/ CLR	88,89 90,91 92,93	○	○	○	○	○	○	○	○	○	○	○		○	○	○
FRR	96,97	⊙	○	○	⊙	⊙	○	⊙	○	○	○	⊙	○		○	⊙
PWE/ PWP	110,111 200,201	○	○	○	○	○	○	○	○	○	○	○	○	○		○
FST	122,123	⊙	X	○	⊙	⊙	X	⊙	○	○	○	⊙	○	X	○	

⊙ Priority ○ Enabled X Disabled

## 11.7 Output Terminal Function

### • Table of output terminal functions 1

Function No.	Code	Function	Action	Reference
0	LL	Frequency lower limit	ON: Output frequency is more than $L L$ OFF: Output frequency is $L L$ or less	5.9
1	LLN	Inversion of frequency lower limit	Inversion of LL	
2	UL	Frequency upper limit	ON: Output frequency is $U L$ or more OFF: Output frequency is less than $U L$	5.9
3	ULN	Inversion of frequency upper limit	Inversion of UL	
4	LOW	Low-speed detection signal	ON: Output frequency is $F 100$ or more OFF: Output frequency is less than $F 100$	7.2.2 6.1.1
5	LOWN	Inversion of low-speed detection signal	Inversion of LOW	
6	RCH	Output frequency attainment signal (acceleration/deceleration completed)	ON: Output frequency is within command frequency $\pm F 102$ OFF: Output frequency is more than command frequency $\pm F 102$	6.1.2
7	RCHN	Inversion of output frequency attainment signal (inversion of acceleration/deceleration completed)	Inversion of RCHF	
8	RCHF	Set frequency attainment signal	ON: Output frequency is within $F 101 \pm F 102$ OFF: Output frequency is more than $F 101 \pm F 102$	6.1.3
9	RCHFN	Inversion of set frequency attainment signal	Inversion of RCHF	
10	FL	Fault signal (trip output)	ON: Inverter tripped OFF: Inverter not tripped	7.2.2
11	FLN	Inversion of fault signal (inversion of trip output)	Inversion of FL	
14	POC	Over-current detection pre-alarm	ON: Output current is $F 601$ or more OFF: Output current is less than $F 601$	6.16.2
15	POCN	Inversion of over-current detection pre-alarm	Inversion of POC	
16	POL	Overload detection pre-alarm	ON: 50% or more of calculated value of overload protection level OFF: Less than 50% of calculated value of overload protection level	3.5
17	POLN	Inversion of overload detection pre-alarm	Inversion of POL	
20	POH	Overheat detection pre-alarm	ON: Approx. 95°C or more of IGBT element OFF: Less than approx. 95°C of IGBT element (90°C or less after detection is turned on)	-
21	POHN	Inversion of overheat detection pre-alarm	Inversion of POH	
22	POP	Overvoltage detection pre-alarm	ON: Overvoltage limit in operation OFF: Overvoltage detection canceled	6.12.4
23	POPn	Inversion of overvoltage detection pre-alarm	Inversion of POP	
24	MOFF	Power circuit undervoltage detection	ON: Power circuit undervoltage (MOFF) detected OFF: Undervoltage detection canceled	6.16.12
25	MOFFN	Inversion of power circuit undervoltage detection	Inversion of MOFF	
26	UC	Small current detection	ON: After output current comes to $F 511$ or less, value of less than $F 511 + F 609$ for $F 512$ set time OFF: Output current is more than $F 511$ ( $F 511 + F 609$ or more after detection turns on)	6.16.7
27	UCN	Inversion of small current detection	Inversion of UC	
28	OT	Over-torque detection	ON: After torque comes to $F 515$ or more, value of more than $F 515 - F 519$ for $F 518$ set time OFF: Torque is less than $F 515$ ( $F 515 - F 519$ or less after detection turns on)	6.16.9
29	OTN	Inversion of over-torque detection	Inversion of OT	

• Table of output terminal functions 2

Function No.	Code	Function	Action	Reference
40	RUN	Run/stop	ON: While operation frequency is output or DC braking is in operation ( <i>db</i> ) OFF: Operation stopped Inversion of RUN	3.2.1
41	RUNN	Inversion of run/stop		
56	COT	Cumulative operation time alarm	ON: Cumulative operation time is $F \bar{6} \bar{2} !$ or more OFF: The cumulative operation time is less than $F \bar{6} \bar{2} !$	6.16.11
57	COTN	Inversion of cumulative operation time alarm	Inversion of COT	
60	FR	Forward/reverse run	ON: Reverse run OFF: Forward run (The last status is held while motor operation is stopped)	3.2.1
61	FRN	Inversion of forward/reverse run	Inversion of FR	
78	COME	RS485 communication error	ON: Communication error occurred OFF: Communication works	6.19
79	COMEN	Inversion of RS485 communication error	Inversion of COME	
92	DATA	Designated data output	ON: bit0 of FA50 is ON OFF: bit0 of FA50 is OFF	6.19
93	DATAN	Inversion of designated data output	Inversion of DATA	
128	LTA	Parts replacement alarm	ON: Any one of cooling fan, control board capacitor, or main circuit capacitor reaches parts replacement time OFF: Any one of cooling fan, control board capacitor, or main circuit capacitor does not reach parts replacement time	6.16.14
129	LTAN	Inversion of parts replacement alarm	Inversion of LTA	
146	FLR	Fault signal (output also at a retry)	ON: While inverter is tripped or retried OFF: While inverter is not tripped and not retried	6.12.3
147	FLRN	Inversion of fault signal (output also at a retry)	Inversion of FLR	
254	AOFF	Always OFF	Always OFF	7.2.2
255	AON	Always ON	Always ON	7.2.2

Note 1: As function No. 12, 13, 18, 19, 30 to 39, 42 to 55, 58, 59, 62 to 77, 80 to 91, 94 to 127, 130 to 145 and 148 to 253 are "No function", output signal is always "OFF" at even number, output signal is always "ON" at odd number.

Note 2: Function No. are different from those on the VF-nC1. Pay attention to substitute function No. from VF-nC1 to VF-nC3.

# 12. Specifications

## 12.1 Models and their standard specifications

### ■ Standard specifications

Item		Specification							
Input voltage class		3-phase 240V class							
Applicable motor (kW)		0.1	0.2	0.4	0.75	1.5	2.2	4.0	
Rating	Type	VFNC3							
	Form	2001P	2002P	2004P	2007P	2015P	2022P	2037P	
	Capacity (kVA) Note 1)	0.3	0.6	1.0	1.6	2.9	3.9	6.4	
	Output current (A) Note 2)	0.7	1.4	2.4	4.2	7.5	10.0	16.7	
	Output voltage Note 3)	(0.7)	(1.4)	(2.4)	(3.6)	(7.5)	(8.5)	(14.0)	
Overload current rating		3-phase 200V to 240V							
Voltage-frequency		150%-60 seconds, 200%-0.5 second							
Allowable fluctuation		3-phase 200V to 240V - 50/60Hz							
Required Power supply capacity (kVA) Note 5)		Voltage 170 to 264V Note 4), frequency ±5%							
Protective method (IEC60529)		0.5	0.8	1.4	2.5	4.3	5.7	9.2	
Cooling method		Self-cooling				IP20			
Color		RAL 3002 / 7016							
Built-in filter		-							

Item		Specification									
Input voltage class		1-phase 240V class					1-phase 120V class				
Applicable motor (kW)		0.1	0.2	0.4	0.75	1.5	2.2	0.1	0.2	0.4	0.75
Rating	Type	VFNC3S									
	Form	2001PL	2002PL	2004PL	2007PL	2015PL	2022PL	1001P	1002P	1004P	1007P
	Capacity (kVA) Note 1)	0.3	0.6	1.0	1.6	2.9	3.9	0.3	0.6	1.0	1.6
	Output current (A) Note 2)	0.7	1.4	2.4	4.2	7.5	10.0	0.7	1.4	2.4	4.2
	Rated output voltage Note 3)	(0.7)	(1.4)	(2.4)	(3.2)	(7.5)	(9.1)	(0.7)	(1.4)	(2.4)	(4.0)
Overload current rating		3-phase 200V to 240V					3-phase 200V to 240V				
Voltage-frequency		150%-60 seconds, 200% -0.5 second					150%-60 seconds, 200%-0.5 second				
Allowable fluctuation		1-phase 200V to 240V - 50/60Hz					1-phase 100V to 120V - 50/60Hz				
Required Power supply capacity (kVA) Note 5)		Voltage 170 to 264V Note 4), frequency ±5%					Voltage 85 to 132V Note 4), frequency±5%				
Protective method (IEC60529)		IP20					IP20				
Cooling method		Self-cooling			Forced air-cooled		Self-cooling			Forced air-cooled	
Color		RAL 3002 / 7016					RAL 3002 / 7016				
Built-in filter		EMC filter					-				

Note 1. Capacity is calculated at 220V for output voltage.

Note 2. Indicates rated output current setting when the PWM carrier frequency (parameter  $F_{300}$ ) is 4kHz or less. Between 5 kHz and 12 kHz, the rated output current is indicated in the ( ). Above 13 kHz, the output current must be reduced. The default setting of the PWM carrier frequency is 12kHz. (Refer to section 6.11 in E6581595)

Note 3. Maximum output voltage is the same as the input voltage. In case of 1-phase 120V class, maximum output voltage is same as twice the input voltage.

With regard to 120V models, the output voltage may decrease about 10 to 20 % if motor load is applied. When operating VFNC3 in conjunction with general-purpose motor (200V), it is necessary to reduce the motor load.

Note 4. 180V-264V (240V class), 90V-132V (120V class) when the inverter is used continuously (load of 100%).

Note 5. Required power supply capacity varies with the value of the power supply side inverter impedance (including those of the input reactor and cables).

## ■ Common specification

	Item	Specification
Principal control functions	Control system	Sinusoidal PWM control
	Output voltage range	Adjustable within the range of 50 to 330V by correcting the supply voltage Note1)
	Output frequency range	0.1 to 400.0Hz, default setting: 0.5 to 80Hz, maximum frequency: 30 to 400Hz
	Minimum setting steps of frequency	0.1Hz: analog input (when the max. frequency is 100Hz), 0.01Hz: Operation panel setting and communication setting.
	Frequency accuracy	Digital setting: within $\pm 0.1\%$ of the max. frequency (-10 to +60°C) Analog setting: within $\pm 1.0\%$ of the max. frequency (25°C $\pm 10^\circ\text{C}$ )
	Voltage/frequency characteristics	V/f constant, variable torque, automatic torque boost, vector control, automatic energy-saving, Auto-tuning, Base frequency (20-400Hz) adjusting to 1 & 2, torque boost (0-30%) adjusting to 1 & 2, adjusting frequency at start (0.1-10Hz)
	Frequency setting signal	Setting dial on the front panel, external frequency potentiometer (connectable to a potentiometer with a rated impedance of 1k-10k $\Omega$ ), 0-10Vdc / 0-5Vdc (input impedance: VI=40k $\Omega$ ), 4-20mAdc (input impedance: 250 $\Omega$ ). Note 2)
	Terminal board base frequency	The characteristic can be set arbitrarily by two-point setting. Possible to set: analog input (VI).
	Frequency jump	Setting of the jump frequency and the range.
	Upper- and lower-limit frequencies	Upper-limit frequency: 0 to max. frequency, lower-limit frequency: 0 to upper-limit frequency
PWM carrier frequency	Adjustable range of 2k to 16kHz (default: 12kHz).	
PID control	Setting of proportional gain, integral gain, differential gain and control waiting time.	
Operation specifications	Acceleration/deceleration time	Selectable from among acceleration/deceleration times 1 & 2 (0.0 to 3000 sec.). Automatic acceleration/deceleration function. S-pattern acceleration/deceleration 1 & 2. Control of forced rapid deceleration.
	DC braking	Braking start-up frequency: 0 to maximum frequency, braking rate: 0 to 100%, braking time: 0 to 25.5 seconds, emergency DC braking.
	Dynamic Braking Drive Circuit	None (braking module is optional)
	Input terminal function (programmable)	Possible to select from among about 60 functions, such as forward/reverse run signal input, jog run signal input, operation base signal input and reset signal input, to assign to 5 input terminals. Logic selectable between sink and source.
	Output terminal functions (programmable)	Possible to select from among about 40 functions, such as upper/lower limit frequency signal output, low speed detection signal output, specified speed reach signal output and failure signal output, to assign to FL relay output, open collector output terminals.
	Forward/reverse run	The RUN and STOP keys on the operation panel are used to start and stop operation, respectively. Forward/reverse run possible through communication and logic inputs from the terminal block.
	Jog run	Jog mode, if selected, allows jog operation from the terminal board.
	Preset speed operation	Frequency references + 15-speed operation possible by changing the combination of 4 contacts on the terminal board.
	Retry operation	Capable of restarting automatically after a check of the main circuit elements in case the protective function is activated. 10 times (Max.) (selectable with a parameter)
	Various prohibition settings / Password setting	Possible to write-protect parameters and to prohibit the change of panel frequency settings and the use of operation panel for operation, emergency stop or resetting. Possible to write-protect parameters by setting 4 digits password and terminal input.
	Regenerative power ride-through control	Possible to keep the motor running using its regenerative energy in case of a momentary power failure (default: OFF).
	Auto-restart operation	In the event of a momentary power failure, the inverter reads the rotational speed of the coasting motor and outputs a frequency appropriate to the rotational speed in order to restart the motor smoothly. This function can also be used when switching to commercial power.
	Failure detection signal	1c- contact output Note 3) Maximum switching capacity : 250Vac-2A , 30Vdc-2A (At resistive load $\cos\Phi=1$ ), 250Vac-1A ( $\cos\Phi=0.4$ ) , 30Vdc-1A (L/R=7ms) Minimum permissible load : 5Vdc-100mA, 24Vdc-5mA

&lt;Continued overleaf&gt;



&lt;Continued&gt;

	Item	Specification
Protective function	Protective function	Stall prevention, current limitation, over-current, output short circuit, over-voltage, over-voltage limitation, undervoltage, ground fault, detection, input phase failure, output phase failure, overload protection by electronic thermal function, armature over-current at start-up, load side over-current at start-up, over-torque, undercurrent, overheating, cumulative operation time, life alarm, emergency stop, various pre-alarms
	Electronic thermal characteristic	Switching between standard motor and constant-torque VF motor, switching between motors 1 & 2, setting of overload trip time, adjustment of stall prevention levels 1 & 2, selection of overload stall
	Reset function	Function of resetting by closing contact 1a or by turning off power of the operation panel. This function is also used to save and clear trip records.
Display function	Alarms	Stall prevention, overvoltage, overload, under-voltage, setting error, retry in process, upper/lower limits
	Causes of failures	Over-current, overvoltage, overheat, output short-circuit, ground fault, overload on inverter, arm overcurrent at start-up, overcurrent on the load side at start-up, CPU fault, EEPROM fault, RAM fault, ROM fault, communication error. (Selectable: emergency stop, under-voltage, small current, over-torque, motor overload, input phase failure, output phase failure)
	Monitoring function	Operation frequency, operation frequency command, forward/reverse run, output current, input voltage (DC detection), output voltage, torque, torque current, load factor of inverter, input power, output power, information on input terminals, information on output terminals, logic input terminals setting, version of CPU1, version of CPU2, PID feedback value, frequency command (after compensation), causes of past trips 1 to 4, parts replacement alarm, cumulative operation time
	Past trip monitoring function	Stores data on the past four trips: number of trips that occurred in succession, operation frequency, forward/reverse run, output current, input voltage (DC detection), output voltage, information on input terminals, information on output terminals, and cumulative operation time when each trip occurred.
	Output for frequency meter	Analog output for meter: 1mA dc full-scale dc ammeter 0 - 20mA (4 to 20mA) output: DC ammeter (allowable load resistance: Less than 750Ω) 0 - 10V output: DC voltmeter (allowable load resistance: Over 1kΩ) Resolution: Maximum of 1/255
	4-digit 7-segments LED	Frequency: inverter output frequency. Alarm: stall alarm "C", overvoltage alarm "P", overload alarm "L", overheat alarm "H". Status: inverter status (frequency, cause of activation of protective function, input/output voltage, output current, etc.) and parameter settings. Free-unit display: arbitrary unit (e.g. rotating speed) corresponding to output frequency.
Indicator	Lamps indicating the inverter status by lighting, such as RUN lamp, MON lamp, PRG lamp, % lamp, Hz lamp. The charge lamp indicates that the main circuit capacitors are electrically charged.	
Environments	Location of use	Indoors: not exposed to direct sunlight, corrosive gas, explosive gas, flammable gas, oil mist, or dust; and vibration of less than 5.9m/s <sup>2</sup> (10 to 55Hz).
	Elevation	3000 m or less (current reduction required over 1000 m) Note 4)
	Ambient temperature	-10 to +60°C Note 5)
	Storage temperature	-25 to +70°C
	Relative humidity	5 to 95% (free from condensation and vapor).

Note 1. Maximum output voltage is the same as the input voltage.

With regard to 120V models, the output voltage may decrease about 10 to 20 % if motor load is applied. When operating VFNC3 in conjunction with general-purpose motor (200V), it is necessary to reduce the motor load.

Note 2. Be careful, if 4-20mA is selected, when the inverter's power is ON, the internal impedance is 250Ω, but when the power is OFF, the internal impedance increases very much to approximately 40kΩ.

Note 3. A chattering (momentary ON/OFF of contact) is generated by external factors of the vibration and the impact, etc. In particular, please set the filter of 10ms or more, or timer for measures when connecting it directly with input unit terminal of programmable controller. Please use the OUT terminal as much as possible when the programmable controller is connected.

Note 4. Current must be reduced by 1% for each 100 m over 1000 m. For example, 90% at 2000m and 80% at 3000m.

Note 5. Above 40°C : Remove the protective seal from the top of VF-Nc3.

Above 50°C: Remove the seal from the top of the inverter and use the inverter with the output current reduced.

Side by side installation (with no space between inverters): Remove the seal from the top of each inverter. When installing the inverter where the ambient temperature will rise above 40°C, remove the seal from the top of the inverter and use the inverter with the output current reduced.

(Refer to section 6.11 in E6581595 for details)

## 12.2 Outside dimensions and mass

### ■ Outside dimensions and mass

Voltage class	Applicable motor (kW)	Inverter type	Dimensions (mm)						Drawing	Approx. weight (kg)
			W	H	D	W1	H1	H2		
3-phase 240V	0.1	VFNC3-2001P	72	130	102	60	131	13	A	1.0
	0.2	VFNC3-2002P			121					
	0.4	VFNC3-2004P			131					
	0.75	VFNC3-2007P	105		131	93	118	14	B	1.5
	1.5	VFNC3-2015P								
	2.2	VFNC3-2022P								
4.0	VFNC3-2037P	140	170	141	126	157	14	E	2.0	
1-phase 240V	0.1	VFNC3S-2001PL	72	130	102	60	131	13	A	1.0
	0.2	VFNC3S-2002PL			121					
	0.4	VFNC3S-2004PL			131					
	0.75	VFNC3S-2007PL	105		156	93	118	12	B	1.5
	1.5	VFNC3S-2015PL								
	2.2	VFNC3S-2022PL								
1-phase 120V	0.1	VFNC3S-1001P	72	130	102	60	131	13	A	1.0
	0.2	VFNC3S-1002P			121					
	0.4	VFNC3S-1004P	105		156	93	118	12	B	1.5
	0.75	VFNC3S-1007P								

### ■ Outline drawing

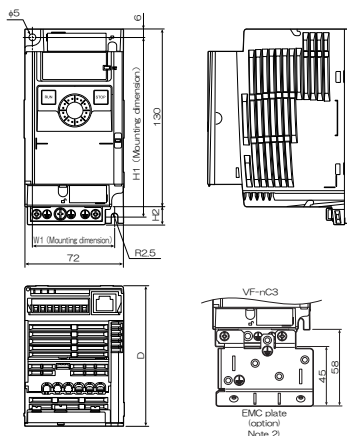

Fig.A

Note 1. To make it easier to grasp the dimensions of each inverter, dimensions common to all inverters in these figures are shown with numeric values but not with symbols.

Here are the meanings of the symbols used.

W: Width

H: Height

D: Depth

W1: Mounting dimension (horizontal)

H1: Mounting dimension (vertical)

H2: Height of EMC plate mounting area

Note 2. Here are the available EMC plate

Fig.A, B : EMP007Z (Approx. weight : 0.3kg)

Fig.C, D : EMP008Z (Approx. weight : 0.4kg)

Fig.E : EMP009Z (Approx. weight : 0.5kg)

Note 3. The models shown in Fig. A to Fig. D are fixed at two points: in the upper left and lower right corners.

Note 4. The model shown in Fig. A, B is not equipped with a cooling fan.

Note 5. Height measurements in Fig. A do not include the protuberance for installation.

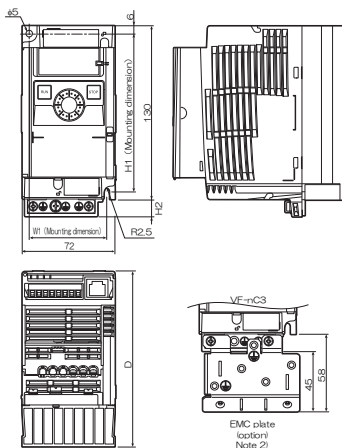

Fig.B

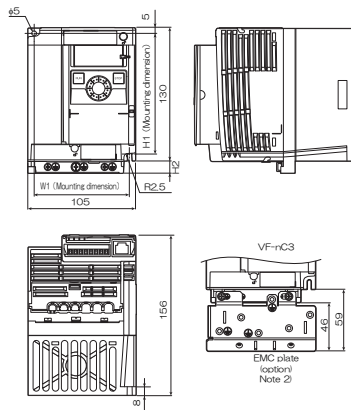

Fig.C

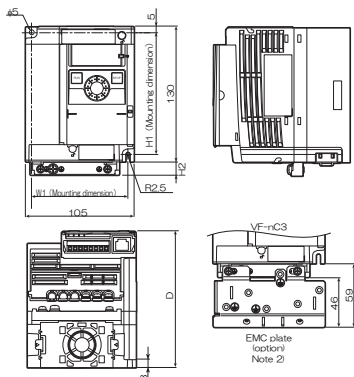

Fig.D

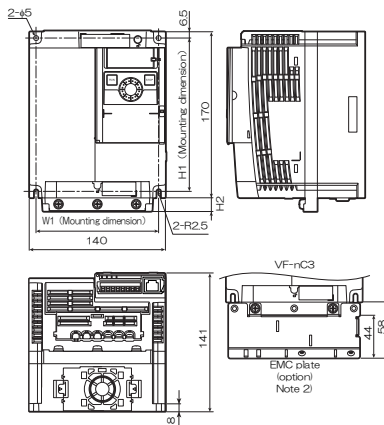

Fig.E

# 13. Before making a service call

## - Trip information and remedies

### 13.1 Trip causes/warnings and remedies

When a problem arises, diagnose it in accordance with the following table.

If it is found that replacement of parts is required or the problem cannot be solved by any remedy described in the table, contact your Toshiba dealer.

#### [Trip information]

Error code	Failure code	Problem	Possible causes	Remedies
$\overline{O}C1$	0001	Overcurrent during acceleration	<ul style="list-style-type: none"> <li>The acceleration time <math>R\overline{L}C</math> is too short.</li> <li>The V/F setting is improper.</li> <li>A restart signal is input to the rotating motor after a momentary stop, etc.</li> <li>A special motor (e.g. motor with a small impedance) is used.</li> </ul>	<ul style="list-style-type: none"> <li>Increase the acceleration time <math>R\overline{L}C</math>.</li> <li>Check the V/F parameter.</li> <li>Use <math>F3\overline{Q}1</math> (auto-restart) and <math>F3\overline{Q}2</math> (ride-through control).</li> <li>In case of <math>P\overline{L}=\overline{0}</math>, decrease <math>\alpha\overline{b}</math>.</li> <li>In case of <math>P\overline{L}=2, 3, 4</math>, set <math>F415</math> (Motor rated current) and make an auto-tuning.</li> </ul>
$\overline{O}C2$	0002	Overcurrent during deceleration	<ul style="list-style-type: none"> <li>The deceleration time <math>d\overline{L}C</math> is too short.</li> </ul>	<ul style="list-style-type: none"> <li>Increase the deceleration time <math>d\overline{L}C</math>.</li> </ul>
$\overline{O}C3$	0003	Overcurrent during constant speed operation	<ul style="list-style-type: none"> <li>The load fluctuates abruptly.</li> <li>The load is in an abnormal condition.</li> </ul>	<ul style="list-style-type: none"> <li>Reduce the load fluctuation.</li> <li>Check the load (operated machine).</li> </ul>
$\overline{O}C4$	0004	Overcurrent (An overcurrent on the load side at start-up)	<ul style="list-style-type: none"> <li>The insulation of the output main circuit or motor is defective.</li> <li>The motor has too small impedance.</li> </ul>	<ul style="list-style-type: none"> <li>Check the secondary wiring and insulation state.</li> <li>Set <math>F513=2, 3</math>.</li> </ul>
$\overline{O}C\overline{R}$	0005	Arm overcurrent at start-up	<ul style="list-style-type: none"> <li>A main circuit element is defective.</li> </ul>	<ul style="list-style-type: none"> <li>Make a service call.</li> </ul>
* $\overline{E}PH1$	0008	Input phase failure	<ul style="list-style-type: none"> <li>A phase failure occurred in the input line of the main circuit.</li> <li>The capacitor in the main circuit lacks capacitance.</li> </ul>	<ul style="list-style-type: none"> <li>Check the main circuit input line for phase failure.</li> <li>Set input phase failure detection selection <math>F5\overline{Q}\overline{Q}=\overline{0}</math>.</li> <li>Check the capacitor in the main circuit for exhaustion.</li> </ul>
* $\overline{E}PH\overline{Q}$	0009	Output phase failure	<ul style="list-style-type: none"> <li>A phase failure occurred in the output line of the main circuit.</li> </ul>	<ul style="list-style-type: none"> <li>Check the main circuit output line, motor, etc. for phase failure.</li> <li>Set output phase failure detection selection <math>F5\overline{Q}5=\overline{0}</math>.</li> </ul>
$\overline{O}P1$	000A	Overvoltage during acceleration	<ul style="list-style-type: none"> <li>The input voltage fluctuates abnormally.</li> <li>(1) The power supply has a capacity of 200kVA or more.</li> <li>(2) A power factor improvement capacitor is opened or closed.</li> <li>(3) A system using a thyristor is connected to the same power distribution line.</li> <li>A restart signal is input to the rotating motor after a momentary stop, etc.</li> </ul>	<ul style="list-style-type: none"> <li>Insert a suitable input reactor.</li> <li>Use <math>F3\overline{Q}1</math> (auto-restart) and <math>F3\overline{Q}2</math> (ride-through control).</li> </ul>

\* You can select a trip ON/OFF by parameters.

(Continued overleaf)

(Continued)

Error code	Failure code	Problem	Possible causes	Remedies
$\overline{OP2}$	000B	Overvoltage during deceleration	<ul style="list-style-type: none"> <li>The deceleration time <math>d\overline{EL}</math> is too short. (Regenerative energy is too large.)</li> <li>Overvoltage limit operation <math>F\overline{305}</math> is set to 1. (Disabled).</li> <li>The input voltage fluctuates abnormally.               <ol style="list-style-type: none"> <li>The power supply has a capacity of 200kVA or more.</li> <li>A power factor improvement capacitor is opened and closed.</li> <li>A system using a thyristor is connected to the same power distribution line.</li> </ol> </li> </ul>	<ul style="list-style-type: none"> <li>Increase the deceleration time <math>d\overline{EL}</math>.</li> <li>Set overvoltage limit operation <math>F\overline{305}</math> to 0, 2, 3.</li> <li>Insert a suitable input reactor.</li> </ul>
$\overline{OP3}$	000C	Overvoltage during constant-speed operation	<ul style="list-style-type: none"> <li>The input voltage fluctuates abnormally.               <ol style="list-style-type: none"> <li>The power supply has a capacity of 200kVA or more.</li> <li>A power factor improvement capacitor is opened or closed.</li> <li>A system using a thyristor is connected to the same power distribution line.</li> </ol> </li> <li>The motor is in a regenerative state because the load causes the motor to run at a frequency higher than the inverter output frequency.</li> </ul>	<ul style="list-style-type: none"> <li>Insert a suitable input reactor.</li> <li>Install an optional brake module.</li> </ul>
$\overline{OL1}$	000D	Inverter overload	<ul style="list-style-type: none"> <li>The acceleration time ACC is too short.</li> <li>The DC braking amount is too large.</li> <li>The V/F setting is improper.</li> <li>A restart signal is input to the rotating motor after a momentary stop, etc.</li> <li>The load is too large.</li> </ul>	<ul style="list-style-type: none"> <li>Increase the acceleration time <math>\overline{ACC}</math>.</li> <li>Reduce the DC braking amount <math>F\overline{251}</math> and the DC braking time <math>F\overline{252}</math>.</li> <li>Check the V/F parameter setting.</li> <li>Use <math>F\overline{301}</math> (auto-restart) and <math>F\overline{302}</math> (ride-through control).</li> <li>Use an inverter with a larger rating.</li> </ul>
$\overline{OL2}$	000E	Motor overload	<ul style="list-style-type: none"> <li>The V/F setting is improper.</li> <li>The motor is locked up.</li> <li>Low-speed operation is performed continuously.</li> <li>An excessive load is applied to the motor during operation.</li> </ul>	<ul style="list-style-type: none"> <li>Check the V/F parameter setting.</li> <li>Check the load (operated machine).</li> <li>Adjust <math>\overline{OLn}</math> to the overload that the motor can withstand during operation in a low speed range.</li> </ul>
$\overline{OL3}$	003E	Main module overload	<ul style="list-style-type: none"> <li>The carrier frequency is high and load current has increased at low speeds (mainly at 15Hz or less).</li> </ul>	<ul style="list-style-type: none"> <li>Raise the operation frequency.</li> <li>Reduce the load.</li> <li>Reduce the carrier frequency.</li> <li>When an operating motor is started up at 0Hz, use the auto-restart function.</li> <li>Set carrier frequency control mode selection <math>F\overline{316}</math> to 1. (carrier frequency with automatic reduction).</li> </ul>
* $\overline{Ot}$	0020	Over-torque trip	<ul style="list-style-type: none"> <li>Over-torque reaches to a detection level during operation.</li> </ul>	<ul style="list-style-type: none"> <li>Enable <math>F\overline{615}</math> (over-torque trip selection).</li> <li>Check system error.</li> </ul>
$\overline{OH}$	0010	Overheat	<ul style="list-style-type: none"> <li>The cooling fan does not rotate.</li> <li>The ambient temperature is too high.</li> <li>The vent is blocked up.</li> <li>A heat generating device is installed close to the inverter.</li> </ul>	<ul style="list-style-type: none"> <li>The fan requires replacement if it does not rotate during operation.</li> <li>Restart the operation by resetting the inverter after it has cooled down enough.</li> <li>Restart the operation by resetting the inverter after it has cooled down enough.</li> <li>Secure sufficient space around the inverter.</li> <li>Do not place any heat generating device near the inverter.</li> </ul>

\* You can select a trip ON/OFF by parameters.

(Continued overleaf)

(Continued)

Error code	Failure code	Problem	Possible causes	Remedies
$\xi$	0011	Emergency stop	<ul style="list-style-type: none"> <li>During automatic operation or remote operation, a stop command is entered from the operation panel or a remote input device.</li> </ul>	<ul style="list-style-type: none"> <li>Reset the inverter.</li> <li>If the emergency stop signal is input, reset after releasing this signal.</li> </ul>
$\xi\xi P 1$	0012	EEPROM fault 1	<ul style="list-style-type: none"> <li>A data writing error occurs.</li> </ul>	<ul style="list-style-type: none"> <li>Turn off the inverter, then turn it again. If it does not recover from the error, make a service call.</li> </ul>
$\xi\xi P 2$	0013	EEPROM fault 2	<ul style="list-style-type: none"> <li>Power supply is cut off during <math>\xi Y P</math> operation and data writing is aborted.</li> <li>The error occurred when various data was written.</li> </ul>	<ul style="list-style-type: none"> <li>Turn the power off temporarily and turn it back on, and then try <math>\xi Y P</math> operation again.</li> <li>Write the data again. Make a service call when it happening frequently.</li> </ul>
$\xi\xi P 3$	0014	EEPROM fault 3	<ul style="list-style-type: none"> <li>A data reading error occurred.</li> </ul>	<ul style="list-style-type: none"> <li>Turn off the inverter, then turn it again. If it does not recover from the error, make a service call.</li> </ul>
$\xi r r 2$	0015	Main unit RAM fault	<ul style="list-style-type: none"> <li>The control RAM is defective.</li> </ul>	<ul style="list-style-type: none"> <li>Make a service call.</li> </ul>
$\xi r r 3$	0016	Main unit ROM fault	<ul style="list-style-type: none"> <li>The control ROM is defective.</li> </ul>	<ul style="list-style-type: none"> <li>Make a service call.</li> </ul>
$\xi r r 4$	0017	CPU fault 1	<ul style="list-style-type: none"> <li>The control CPU is defective.</li> </ul>	<ul style="list-style-type: none"> <li>Make a service call.</li> </ul>
$\xi r r 5$	0018	Remote control error	<ul style="list-style-type: none"> <li>The communication was broken off.</li> </ul>	<ul style="list-style-type: none"> <li>Check the remote control device, cables, etc.</li> </ul>
$\xi r r 7$	001A	Current detector fault	<ul style="list-style-type: none"> <li>The current detector is defective.</li> </ul>	<ul style="list-style-type: none"> <li>Make a service call.</li> </ul>
* $u\bar{c}$	001D	Low-current operation Trip	<ul style="list-style-type: none"> <li>The output current decreased to a low-current detection level during operation.</li> </ul>	<ul style="list-style-type: none"> <li>Enable <math>F 6 1 0</math> (low-current detection).</li> <li>Check the suitable detection level for the system (<math>F 6 0 9</math>, <math>F 6 1 1</math>, <math>F 6 1 2</math>).</li> <li>Make a service call if the setting is correct.</li> </ul>
* $u P 1$	001E	Undervoltage trip (main circuit)	<ul style="list-style-type: none"> <li>The input voltage (in the main circuit) is too low.</li> </ul>	<ul style="list-style-type: none"> <li>Check the input voltage.</li> <li>Enable <math>F 6 2 7</math> (undervoltage trip selection).</li> <li>To take measures to momentary power failure, set <math>F 6 2 7=0</math> or <math>2</math>.</li> <li>Regenerative power ride-through control <math>F 3 0 2</math> and Auto-restart control selection <math>F 3 0 1</math>.</li> </ul>
$\xi F 2$	0022	Ground fault trip	<ul style="list-style-type: none"> <li>A ground fault occurs in the output cable or the motor.</li> </ul>	<ul style="list-style-type: none"> <li>Check the cable and the motor for ground faults.</li> </ul>
$\xi t n 1$	0054	Auto-tuning error	<ul style="list-style-type: none"> <li>The motor parameter <math>u 1</math>, <math>u L u</math>, <math>F 4 0 5</math>, <math>F 4 1 5</math>, <math>F 4 1 7</math> are not set correctly.</li> <li>The motor with the capacity of 2 classes or less than the inverter is used.</li> <li>The output cable is too thin.</li> <li>The inverter is used for loads other than those of three-phase induction motors.</li> <li>The motor is rotating.</li> </ul>	<ul style="list-style-type: none"> <li>Set the left column parameters correctly as a motor name plate and make an auto-tuning again.</li> <li>Set the left column parameters correctly as a motor name plate and make an auto-tuning again.</li> <li>Then set <math>F 4 0 0=1</math>, when trip occurs.</li> <li>Make an auto-tuning again after the rotation of the motor stops.</li> </ul>
$\xi t Y P$	0029	Inverter type error	<ul style="list-style-type: none"> <li>It may be a breakdown failure.</li> </ul>	<ul style="list-style-type: none"> <li>Make a service call.</li> </ul>
$\xi - 1 3$	0045	Over speed fault	<ul style="list-style-type: none"> <li>The input voltage fluctuates abnormally.</li> <li>Over speed fault due to the overvoltage limit operation.</li> </ul>	<ul style="list-style-type: none"> <li>Check the input voltage.</li> <li>Install an optional braking module.</li> </ul>
* $\xi - 1 8$	0032	Brea in analog signal cable	<ul style="list-style-type: none"> <li>The input signal from VI is equal to or less than the <math>F 6 3 3</math> setting.</li> </ul>	<ul style="list-style-type: none"> <li>Check the VI signal cable for breaks. Also, check the input signal value or setting of <math>F 6 3 3</math>.</li> </ul>
$\xi - 1 9$	0033	CPU communications error	<ul style="list-style-type: none"> <li>A communications error occurs between control CPUs.</li> </ul>	<ul style="list-style-type: none"> <li>Make a service call.</li> </ul>
$\xi - 2 0$	0034	Excessive torque boosted	<ul style="list-style-type: none"> <li>The automatic torque boost parameter <math>F 4 0 2</math> setting is too high.</li> <li>The motor has too small impedance.</li> </ul>	<ul style="list-style-type: none"> <li>Set a lower automatic torque boost parameter <math>F 4 0 2</math> setting.</li> <li>Make an auto-tuning.</li> </ul>
$\xi - 2 1$	0035	CPU fault 2	<ul style="list-style-type: none"> <li>The control CPU is defective.</li> </ul>	<ul style="list-style-type: none"> <li>Make a service call.</li> </ul>
$\xi - 2 6$	003A	CPU fault 3	<ul style="list-style-type: none"> <li>The control CPU is defective.</li> </ul>	<ul style="list-style-type: none"> <li>Make a service call.</li> </ul>

\* You can select a trip ON/OFF by parameters.

[Alarm information] Each message in the table is displayed to give a warning but does not cause the inverter to trip.

Error code	Problem	Possible causes	Remedies
<i>OFF</i> <i>HOFF</i>	ST terminal OFF	• The ST-CC circuit is opened.	• Close the ST-CC circuit.
<i>errY</i>	Undervoltage in main circuit	• The supply voltage between R, S and T is under voltage.	• Measure the main circuit supply voltage (between the terminal PA and PC). If the voltage is at a normal level, the inverter requires repairing.
<i>errY</i>	Retry in process	• The inverter is in process of retry. • A momentary stop occurred. The motor speed is being detected.	• The inverter restarts automatically. Be careful of the machine because it may suddenly restart.
<i>err1</i>	Frequency point setting error alarm	• The frequency setting signals at points 1 and 2 are set too close to each other.	• Set the frequency setting signals at points 1 and 2 apart from each other.
<i>CLR</i>	Clear command acceptable	• This message is displayed when pressing the STOP key while an error code is displayed.	• Press the STOP key again to clear the trip.
<i>EOFF</i>	Emergency stop command acceptable	• The operation panel is used to stop the operation in automatic control or remote control mode.	• Press the STOP key for an emergency stop. To cancel the emergency stop, press any other key.
<i>H1</i> <i>LG</i>	Setting error alarm / An error code and data are displayed alternately twice each.	• An error is found in a setting when data is reading or writing.	• Check whether the setting is made correctly.
<i>HEAd</i> <i>End</i>	Display of first/last data items	• The first and last data item in the <i>RUH</i> data group is displayed.	• Press MODE key to exit the data group.
<i>db</i>	DC braking	• DC braking in process	• The message goes off in several tens of seconds if no problem occurs. Note)
<i>F1</i> <i>F2</i> <i>STOP</i>	Flowing out of excess number of digits	• The number of digits such as frequencies is more than 4. (The upper digits have a priority.)	• Lower the frequency free unit magnification <i>F102</i> .
<i>STOP</i>	Momentary power failure slowdown stop prohibition function activated.	• The slowdown stop prohibition function set with <i>F102</i> (momentary power failure ride-through operation) is activated.	• To restart operation, reset the inverter or input an operation signal again.
<i>LSFP</i>	Auto-stop because of continuous operation at the lower-limit frequency	• The automatic stop function selected with <i>F255</i> was activated.	• This function is cancelled, when frequency reference reaches <i>LL+0.2Hz</i> or operation command is OFF.
<i>inIt</i>	Parameters in the process of initialization	• Parameters are being initialized to default values.	• Normal if the message disappears after a while (several seconds to several tens of seconds).
<i>H-OS</i>	Output frequency upper limit	• An attempt was made to operate at a frequency higher than 10 times the base frequency ( <i>UL</i> or <i>F110</i> ).	• Operate at a frequency within 10 times the base frequency.
<i>H-11</i>	Operation panel key fault	• The RUN or STOP key is held down for more than 20 seconds. • The RUN or STOP key is faulty.	• Check the operation panel.
<i>Aut</i>	Auto-tuning	• Auto-tuning in process	• Normal if it the message disappears after a few seconds.

Note) When the ON/OFF function is selected for DC braking (DB), using the input terminal selection parameter, you can judge the inverter to be normal if "db" disappears when opening the circuit between the terminal and CC.  
(Continued overleaf)

(Continued)

Error code	Problem	Possible causes	Remedies
$E - 49$	External power supply input logic switching check alarm	<ul style="list-style-type: none"> <li>The input terminal was switched to sink logic of external power supply input (+24V).</li> </ul>	<ul style="list-style-type: none"> <li>Check the wiring, and set the appropriate logic.</li> <li>Check to make sure that the wiring is normal, and reset or turn the power off and then back on again. This switches the logic.</li> </ul>
$E - 50$	Source logic switching check alarm	<ul style="list-style-type: none"> <li>The input terminal was switched to source logic.</li> </ul>	
$E - 51$	Sink logic switching check alarm	<ul style="list-style-type: none"> <li>The input terminal was switched to sink logic.</li> </ul>	<ul style="list-style-type: none"> <li>If the password is correct, <math>PR55</math> is displayed and if it is incorrect, <math>FR1L</math> is displayed.</li> </ul>
$PR55 / FR1L$	Password verification result	<ul style="list-style-type: none"> <li>After the password setting (<math>F738</math>), the password was input to <math>F739</math> (password verification).</li> </ul>	
$ER5Y / 5td$	Switching display of Easy setting mode / Standard setting mode	<ul style="list-style-type: none"> <li>The EASY key was pushed in the standard monitor mode.</li> </ul>	<ul style="list-style-type: none"> <li>When <math>ER5Y</math> is displayed, setting mode becomes easy setting mode. When <math>5td</math> is displayed, it becomes standard setting mode.</li> </ul>
$5Et$ Note)	Input requirement of region setting	<ul style="list-style-type: none"> <li>A region setting is not input yet.</li> <li>As checking the region setting parameter <math>5Et</math> is set to <math>0</math>, inverter return to default setting.</li> <li>As <math>5tP</math> is set to <math>13</math>, inverter return to default setting.</li> </ul>	<ul style="list-style-type: none"> <li>Set a region setting by using setting dial.</li> </ul>
$nErrr$	No trip of past trip	<ul style="list-style-type: none"> <li>No new record of past trip, after past trips were clear.</li> </ul>	<ul style="list-style-type: none"> <li>Normal operation.</li> </ul>
$n---$	No detailed information of past trip	<ul style="list-style-type: none"> <li>The detailed information of past trip is read by pushing the center of setting dial during blinking <math>nErrr5</math> ⇔ number.</li> </ul>	<ul style="list-style-type: none"> <li>Normal operation. To be returned by pressing MODE key.</li> </ul>

Note)  $5Et$  is blinking after power supply is on. In this time, the keys are not operated.  
But parameter  $5Et$  is not blinking as same as other parameters.

[Prealarm display]

$\zeta$	Overcurrent alarm	Same as $0\zeta$ (overcurrent)
$P$	Overvoltage alarm	Same as $0P$ (overvoltage)
$L$	Overload alarm	Same as $0L1$ and $0L2$ (overload)
$H$	Overheat alarm	Same as $0H$ (overheat)
$t$	Communication alarm	Same as $Errr5$ (communication fault)

If two or more problems arise simultaneously, one of the following alarms appears and blinks.

$\zeta P, PL, \zeta PL$

The blinking alarms  $\zeta, P, L, H, t$  are displayed in this order from left to right.



## 13.2 Restoring the inverter from a trip

Do not reset the inverter when tripped because of a failure or error before eliminating the cause. Resetting the tripped inverter before eliminating the problem causes it to trip again.

The inverter can be restored from a trip by any of the following operations:

- (1) By turning off the power (Keep the inverter off until the LED turns off.)  
Note) See inverter trip hold selection  $F502$  for details.
- (2) By means of an external signal (Short circuit across RES and CC on control terminal block → Open): The reset function must be assigned to the input terminal block. (function number 8, 9)
- (3) By panel keypad operation
- (4) By inputting a trip clear signal from communication  
(Refer to communication manual (E6581657) for details.)

To reset the inverter by panel keypad operation, follow these steps.

1. Press the STOP key and make sure that  $Lr$  is displayed.
2. Pressing the STOP key again will reset the inverter if the cause of the trip has already been eliminated.

- ★ When any overload function [ $OL1$ : inverter overload,  $OL2$ : motor overload] is active, the inverter cannot be reset by inputting a reset signal from an external device or by operation panel operation before the virtual cooling time has passed.

Virtual cooling time ...  $OL1$ : about 30 seconds after the occurrence of a trip

$OL2$ : about 120 seconds after a occurrence of a trip

- ★ In case of a trip due to overheat ( $OH$ ), the inverter checks the temperature within. Wait until the temperature in the inverter falls sufficiently before resetting the inverter.
- ★ The inverter cannot be reset while the emergency stop signal is being input from the terminal.

### [Caution]

Turning the inverter off then turning it on again resets the inverter immediately. You can use this mode of resetting if there is a need to reset the inverter immediately. Note, however, that this operation may damage the system or the motor if it is repeated frequently.

## 13.3 If the motor does not run while no trip message is displayed ...

If the motor does not run while no trip message is displayed, follow these steps to track down the cause.

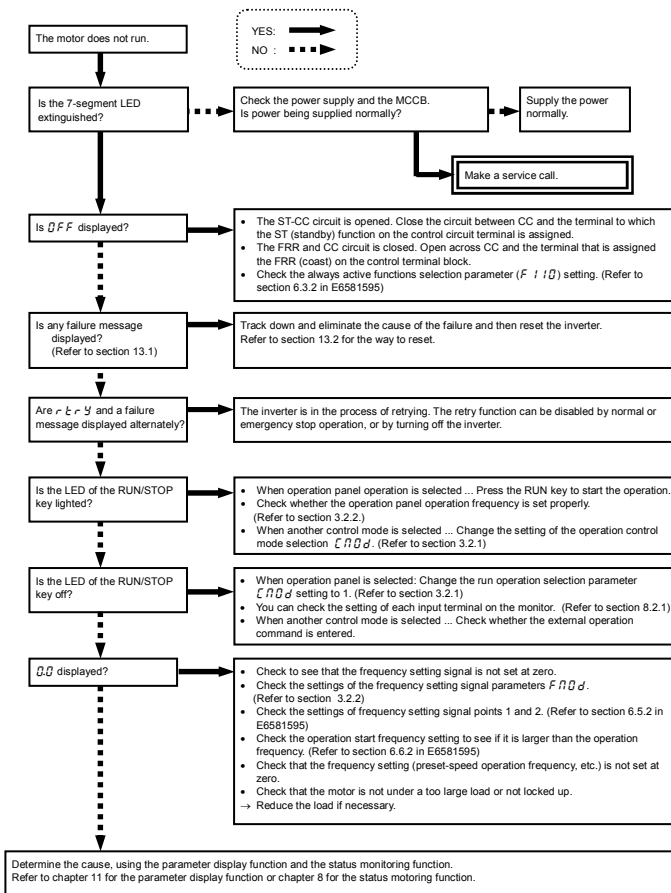

## 13.4 How to determine the causes of other problems



The following table provides a listing of other problems, their possible causes and remedies.

Problems	Causes and remedies
The motor runs in the wrong direction.	<ul style="list-style-type: none"> <li>• Invert the phases of the output terminals U, V and W.</li> <li>• Invert the forward/reverse run-signal terminals of the external input device. (Refer to section 7.2.1 "Assignment of functions to control terminals" in E6581595)</li> <li>• Change the setting of the parameter <math>F r</math> in the case of panel operation.</li> </ul>
The motor runs but its speed does not change normally.	<ul style="list-style-type: none"> <li>• The load is too heavy. Reduce the load.</li> <li>• The soft stall function is activated. Disable the soft stall function. (Refer to section 3.5 in E6581595)</li> <li>• The maximum frequency <math>F H</math> and the upper limit frequency <math>U L</math> are set too low. Increase the maximum frequency <math>F H</math> and the upper limit frequency <math>U L</math>.</li> <li>• The frequency setting signal is too low. Check the signal set value, circuit, cables, etc.</li> <li>• Check the setting characteristics (point 1 and point 2 settings) of the frequency setting signal parameters. (Refer to section 6.5.2 in E6581595)</li> <li>• If the motor runs at a low speed, check to see that the stall prevention function is activated because the torque boost amount is too large. Adjust the torque boost amount (<math>\omega b</math>) and the acceleration time (<math>R L C</math>). (Refer to section 5.12 and 5.3 in E6581595)</li> </ul>
The motor does not accelerate or decelerate smoothly.	<ul style="list-style-type: none"> <li>• The acceleration time (<math>R L C</math>) or the deceleration time (<math>d E L</math>) is set too short. Increase the acceleration time (<math>R L C</math>) or the deceleration time (<math>d E L</math>).</li> </ul>
A too large current flows into the motor.	<ul style="list-style-type: none"> <li>• The load is too heavy. Reduce the load.</li> <li>• If the motor runs at a low speed, check whether the torque boost amount is too large. (Refer to section 5.12 in E6581595)</li> </ul>
The motor runs at a higher or lower speed than the specified one.	<ul style="list-style-type: none"> <li>• The motor has an improper voltage rating. Use a motor with a proper voltage rating.</li> <li>• The motor terminal voltage is too low. Check the setting of the base frequency voltage parameter (<math>\omega L \omega</math>). (Refer to section 5.10 in E6581595) Replace the cable with a cable larger in diameter.</li> <li>• The reduction gear ratio, etc., are not set properly. Adjust the reduction gear ratio, etc.</li> <li>• The output frequency is not set correctly. Check the output frequency range.</li> <li>• Adjust the base frequency. (Refer to section 5.10 in E6581595)</li> </ul>
The motor speed fluctuates during operation.	<ul style="list-style-type: none"> <li>• The load is too heavy or too light. Reduce the load fluctuation.</li> <li>• The inverter or motor used does not have a rating large enough to drive the load. Use an inverter or motor with a rating large enough.</li> <li>• Check whether the frequency setting signal changes.</li> <li>• If the V/F control selection parameter <math>P L</math> is set at 3, check the vector control setting, operation conditions, etc. (Refer to section 5.11 in E6581595)</li> </ul>
Parameter settings cannot be changed.	<p>Change the setting of the parameter setting selection prohibited parameter <math>F 7 \bar{D} \bar{D}</math> to <math>\bar{D}</math> (enabled) if it is set to <math>\bar{1}</math> or <math>\bar{2}</math> (prohibited).</p> <p>* For reasons of safety, some parameters cannot be reprogrammed while the inverter is running. (Refer to section 6.18.1 in E6581595)</p>

### How to cope with parameter setting-related problems

If you forget parameters which have been reset	<ul style="list-style-type: none"> <li>• You can search for all reset parameters and change their settings. * Refer to section 4.3.1 for details.</li> </ul>
If you want to return all reset parameters to their respective default settings	<ul style="list-style-type: none"> <li>• You can return all parameters which have been reset to their default settings. * Refer to section 4.3.2 for details.</li> </ul>

## 14. Inspection and maintenance

 Warning	
 Mandatory action	<ul style="list-style-type: none"> <li>• The equipment must be inspected every day. If the equipment is not inspected and maintained, errors and malfunctions may not be discovered which could lead to accidents.</li> <li>• Before inspection, perform the following steps.               <ol style="list-style-type: none"> <li>(1) Shut off all input power to the inverter.</li> <li>(2) Wait at least 15 minutes and check to make sure that the charge lamp is no longer lit.</li> <li>(3) Use a tester that can measure DC voltages (400V DC or more), and check that the voltage to the DC main circuits (across PA-PC) does not exceed 45V.</li> </ol> </li> </ul> <p style="text-align: center;">Performing an inspection without carrying out these steps first could lead to electric shock.</p>

Be sure to inspect the inverter regularly and periodically to prevent it from breaking down because of the environment of use, such as temperature, humidity, dust and vibration, or deterioration of its components with aging.

### 14.1 Regular inspection

Since electronic parts are susceptible to heat, install the inverter in a cool, well-ventilated and dust-free place.

This is essential for increasing the service life.

The purpose of regular inspections is to maintain the correct environment of use and to find any sign of failure or malfunction by comparing current operation data with past operation records.

Subject of inspection	Inspection procedure			Criteria for judgement
	Inspection item	Inspection cycle	Inspection method	
1. Indoor environment	1) Dust, temperature and gas	Occasionally	1) Visual check, check by means of a thermometer, smell check	1) Improve the environment if it is found to be unfavorable. 2) Check for any trace of water condensation. 3) Max. temperature: 60°C
	2) Drop of water or other liquid	Occasionally	2) Visual check	
	3) Room temperature	Occasionally	3) Check by means of a thermometer	
2. Units and components	1) Vibration and noise	Occasionally	Tactile check of the cabinet	Is something unusual is found, open the door and check the transformer, reactors, contactors, relays, cooling fan, etc., inside. If necessary, stop the operation.
3. Operation data (output side)	1) Load current	Occasionally	Moving-iron type AC ammeter	To be within the rated current, voltage and temperature. No significant difference from data collected in a normal state.
	2) Voltage (*)	Occasionally	Rectifier type AC voltmeter	
	3) Temperature	Occasionally	Thermometer	



\*) The voltage measured may slightly vary from voltmeter to voltmeter. When measuring the voltage, always take readings from the same circuit tester or voltmeter.

## ■ Check points

1. Something unusual in the installation environment
2. Something unusual in the cooling system
3. Unusual vibration or noise
4. Overheating or discoloration
5. Unusual odor
6. Unusual motor vibration, noise or overheating
7. Adhesion or accumulation of foreign substances (conductive substances)

## 14.2 Periodical inspection

Make a periodical inspection at intervals of 3 or 6 months depending on the operating conditions.

 <b>Warning</b>	
 Mandatory action	<ul style="list-style-type: none"> <li>• Before inspection, perform the following steps.               <ol style="list-style-type: none"> <li>(1) Shut off all input power to the inverter.</li> <li>(2) Wait at least 15 minutes and check to make sure that the charge lamp is no longer lit.</li> <li>(3) Use a tester that can measure DC voltages (400V DC or more), and check that the voltage to the DC main circuits (across PA-PC) does not exceed 45V. Performing an inspection without carrying out these steps first could lead to electric shock.</li> </ol> </li> </ul>
 Prohibited	<ul style="list-style-type: none"> <li>• Never replace any part. This could be a cause of electric shock, fire and bodily injury. To replace parts, call the local sales agency.</li> </ul>

## ■ Check items

1. Check to see if all screwed terminals are tightened firmly. If any screw is found loose, tighten it again with a screwdriver.
2. Check to see if all caulked terminals are fixed properly. Check them visually to see that there is no trace of overheating around any of them.
3. Check all cables and wires for damage. Check them visually.
4. Remove dirt and dust. With a vacuum cleaner, remove dirt and dust. When cleaning, clean the vents and the printed circuit boards. Always keep them clean to prevent an accident due to dirt or dust.
5. If no power is supplied to the inverter for a long time, the performance of its large-capacity electrolytic capacitor declines.  
When leaving the inverter unused for a long time, supply it with electricity once every two years, for 5 hours or more each, to recover the performance of the large-capacity electrolytic capacitor. And also check the function of the inverter. It is advisable not to supply the commercial power directly to the inverter but to gradually increase the power supply voltage with a transformer, etc.
6. If the need arises, conduct an insulation test on the main circuit terminal board only, using a 500V insulation tester. Never conduct an insulation test on control terminals other than terminals on the printed circuit board or on control terminals. When testing the motor for insulation performance, separate it from the inverter in advance by disconnecting the cables from the inverter output terminals U, V and W. When conducting an insulation test on peripheral circuits other than the motor circuit, disconnect all cables from the inverter so that no voltage is applied to the inverter during the test.

(Note) Before an insulation test, always disconnect all cables from the main circuit terminal board and test the inverter separately from other equipment..

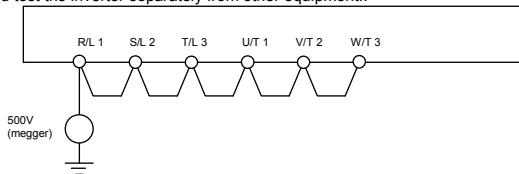

7. Never test the inverter for pressure. A pressure test may cause damage to its components.
8. Voltage and temperature check

Recommended voltmeter : Input side ... Moving-iron type voltmeter (⚡)

Output side ... Rectifier type voltmeter (▶)

It will be very helpful for detecting a defect if you always measure and record the ambient temperature before, during and after the operation.

## ■ Replacement of expendable parts

The inverter is composed of a large number of electronic parts including semiconductor devices.

The following parts deteriorate with the passage of time because of their composition or physical properties.

The use of aged or deteriorated parts leads to degradation in the performance or a breakdown of the inverter. To avoid such trouble, the inverter should be checked periodically.

(Note) Generally, the life of a part depends on the ambient temperature and the conditions of use. The life spans listed below are applicable to parts when used under normal environmental conditions.

### 1) Cooling fan

The fan for cooling heat-generating parts has a service life of about ten years. The fan also needs to be replaced if it makes a noise or vibrates abnormally.

### 2) Smoothing capacitor

The smoothing aluminum electrolytic capacitor in the main circuit DC section degrades in performance because of ripple currents, etc. It becomes necessary to replace the capacitor after it is used for about 5 years under normal conditions. Since the smoothing capacitor is mounted on a printed circuit board, it must be replaced together with the circuit board.

<Criteria for appearance check>

- Absence of liquid leak
- Safety valve in the depressed position
- Measurement of electrostatic capacitance and insulation resistance

Note: Checking the life alarm function is useful for roughly determining the parts replacement time.

To ensure customer safety, you should never replace parts on your own. (It is also possible to monitor the part replacement alarm and output a signal.)

## ■ Standard replacement cycles of principal parts

As guides, the table below lists part replacement cycles that were estimated based on the assumption that the inverter would be used in a normal use environment under normal conditions (ambient temperature, ventilation conditions, and energizing time). The replacement cycle of each part does not mean its service life but the number of years over which its failure rate does not increase significantly.

Also, make use of the life alarm function.

Part name	Standard replacement cycle Note 1:	Replacement mode and others
Cooling fan	10 years	Replacement with a new one (To be determined after inspection)
Main circuit smoothing aluminum electrolytic capacitor	10 years Note 2	Replacement with a new one (To be determined after inspection)
Relays	-	Whether to replace or not depends on the check results
Aluminum electrolytic capacitor mounted on a printed circuit board	10 years Note 2	Replace with a new circuit board (To be determined after inspection)

Note 1: The replacement cycle is calculated on the assumption that the average ambient temperature over a year is 40°C. The environment must be free of corrosive gases, oil mist and dust.

Note 2: Figures are for when the inverter output current is 80% of the rated current of the inverter.

Note 3: The life of parts varies greatly depending on the operating environment.

## 14.3 Making a call for servicing

For the Toshiba service network, refer to the back cover of this instruction manual. If defective conditions are encountered, please contact the Toshiba service section in charge via your Toshiba dealer.

When making a call for servicing, please inform us of the contents of the rating label on the right panel of the inverter, the presence or absence of optional devices, etc., in addition to the details of the failure.

## 14.4 Keeping the inverter in storage

Take the following precautions when keeping the inverter in storage temporarily or for a long period of time.

1. Store the inverter in a well-ventilated place away from heat, damp, dust and metal powder.
2. If no power is supplied to the inverter for a long time, the performance of its large-capacity electrolytic capacitor declines.

When leaving the inverter unused for a long time, supply it with electricity once every two years, for 5 hours or more each, to recover the performance of the large-capacity electrolytic capacitor. And also check the function of the inverter. It is advisable not to supply the commercial power directly to the inverter but to gradually increase the power supply voltage with a transformer, etc.

## 15. Warranty

Any part of the inverter that proves defective will be repaired and adjusted free of charge under the following conditions:

1. This warranty applies only to the inverter main unit.
2. Any part of the inverter which fails or is damaged under normal use within twelve months from the date of delivery shall be repaired free of charge.
3. For the following kinds of failure or damage, the repair cost shall be borne by the customer even within the warranty period.
  - Failure or damage caused by improper or incorrect use or handling, or unauthorized repair or modification of the inverter
  - Failure or damage caused by the inverter falling or an accident during transportation after the purchase
  - Failure or damage caused by fire, salty water or wind, corrosive gas, earthquake, storm or flood, lightning, abnormal voltage supply, or other natural disasters
  - Failure or damage caused by the use of the inverter for any purpose or application other than the intended one
4. All expenses incurred by Toshiba for on-site services shall be charged to the customer, unless a service contract is signed beforehand between the customer and Toshiba, in which case the service contract has priority over this warranty.



## 16. Disposal of the inverter



### Caution



Mandatory  
action

- If you dispose of the inverter, have it done by a specialist in industry waste disposal(\*). If you dispose of the inverter by yourself, this can result in explosion of capacitor or produce noxious gases, resulting in injury.  
(\* ) Persons who specialize in the processing of waste and known as "industrial waste product collectors and transporters" or "industrial waste disposal persons." If the collection, transport and disposal of industrial waste is done by someone who is not licensed for that job, it is a punishable violation of the law. (Laws in regard to cleaning and processing of waste materials)

For safety's sake, do not dispose of the disused inverter yourself but ask an industrial waste disposal agent.

Disposing of the inverter improperly could cause its capacitor to explode and emit toxic gas, causing injury to persons.

---

# TOSHIBA

## TOSHIBA INDUSTRIAL PRODUCTS SALES CORPORATION

International Operations  
9-11, Nihonbashi-honcho 4-chome,  
Chuo-ku, Tokyo 103-0023, Japan  
TEL : +81-(0)3-5644-5509  
FAX : +81-(0)3-5644-5519

## TOSHIBA INTERNATIONAL CORPORATION

13131 West Little York Rd., Houston,  
TX 77041, U.S.A.  
TEL : +1-713-466-0277  
FAX : +1-713-466-8773

## TOSHIBA ASIA PACIFIC PTE., LTD

152 Beach Rd., #16-00 Gateway East,  
Singapore 189721  
TEL : +65-6297-0990  
FAX : +65-6297-5510

## TOSHIBA CHINA CO., LTD

HSBC Tower, 1000 Lujiazui Ring Road,  
Pudong New Area, Shanghai  
200120, The People's Republic of China  
TEL : +86-(0)21-6841-5666  
FAX : +86-(0)21-6841-1161

## TOSHIBA INTERNATIONAL CORPORATION PTY., LTD

2 Morton Street Parramatta, NSW2150, Australia  
TEL : +61-(0)2-9768-6000  
FAX : +61-(0)2-9890-7542

## TOSHIBA INFORMATION, INDUSTRIAL AND POWER SYSTEMS TAIWAN CORP.

6F, No.66, Sec1 Shin Sheng N.RD, Taipei, Taiwan  
TEL : +886-(0)2-2581-3639  
FAX : +886-(0)2-2581-3631

- For further information, please contact your nearest Toshiba Representative or International Operations-Producer Goods.
- The data given in this manual are subject to change without notice.